

RSH4069U CMOS Hex Inverters

1 FEATURES

- **Wide Operating Voltage Range: 3V to 15V**
- **Low Input leakage current of 1μA at 15V over full ambient temperature**
- **5V,10V and 15V Parametric Ratings**
- **Operating Temperature Range: -40°C to 125°C**
- **Micro SIZE PACKAGES: SOP14**

2 APPLICATIONS

- **Logic Inversion**
- **Pulse Shaping**
- **Oscillators**
- **High-Input-Impedance Amplifiers**

Functional Block Diagram

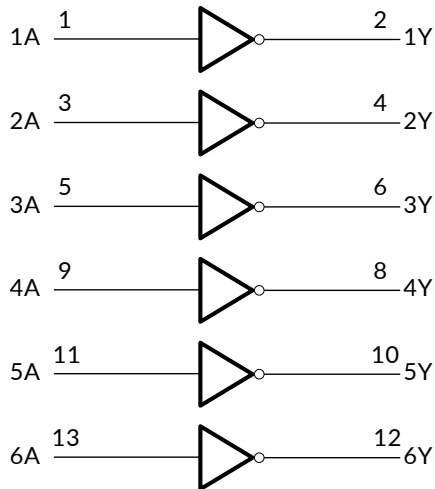

3 DESCRIPTIONS

The RSH4069U device is designed for 3V to 15V V_{cc} operation.

The RSH4069U device contains six inverters and performs the Boolean function $Y = \bar{A}$. This enables the use of current limiting resistors to interface inputs to voltages in excess of V_{cc} .

The RSH4069U is available in Green SOP14 packages. It operates over an ambient temperature range of -40°C to 125°C.

Device Information ⁽¹⁾

PART NUMBER	PACKAGE	BODY SIZE (NOM)
RSH4069U	SOP14	8.65mm×3.90mm

(1) For all available packages, see the orderable addendum at the end of the data sheet.

4 FUNCTION TABLE

INPUTS	OUTPUT
A	Y
H	L
L	H

H=High Voltage Level

L=Low Voltage Level

Table of Contents

1 FEATURES	1
2 APPLICATIONS	1
3 DESCRIPTIONS	1
4 FUNCTION TABLE	1
5 REVISION HISTORY	3
6 PACKAGE/ORDERING INFORMATION ⁽¹⁾	4
7 PIN CONFIGURATIONS	5
8 SPECIFICATIONS	6
8.1 Absolute Maximum Ratings	6
8.2 ESD Ratings	6
9 ELECTRICAL CHARACTERISTICS	7
9.1 Recommended Operating Conditions.....	7
9.2 DC Characteristics	8
9.3 AC Characteristics.....	9
9.4 Typical Performance Characteristics.....	10
10 WAVEFORMS AND TEST CIRCUIT	11
11 PACKAGE OUTLINE DIMENSIONS	12
12 TAPE AND REEL INFORMATION	13

5 REVISION HISTORY

Note: Page numbers for previous revisions may differ from page numbers in the current version.

Version	Change Date	Change Item
A.1	2024/10/17	Initial version completed

6 PACKAGE/ORDERING INFORMATION ⁽¹⁾

PRODUCT	ORDERING NUMBER	TEMPERATURE RANGE	PACKAGE LEAD	PACKAGE MARKING ⁽²⁾	MSL ⁽³⁾	PACKAGE OPTION
RSH4069U	RSH4069UXP	-40°C ~125°C	SOP14	RSH4069U	MSL3	Tape and Reel,4000

NOTE:

- (1) This information is the most current data available for the designated devices. This data is subject to change without notice and revision of this document. For browser-based versions of this data sheet, refer to the right-hand navigation.
- (2) There may be additional marking, which relates to the lot trace code information (data code and vendor code), the logo or the environmental category on the device.
- (3) RUNIC classify the MSL level with using the common preconditioning setting in our assembly factory conforming to the JEDEC industrial standard J-STD-20F, Please align with RUNIC if your end application is quite critical to the preconditioning setting or if you have special requirement.

7 PIN CONFIGURATIONS

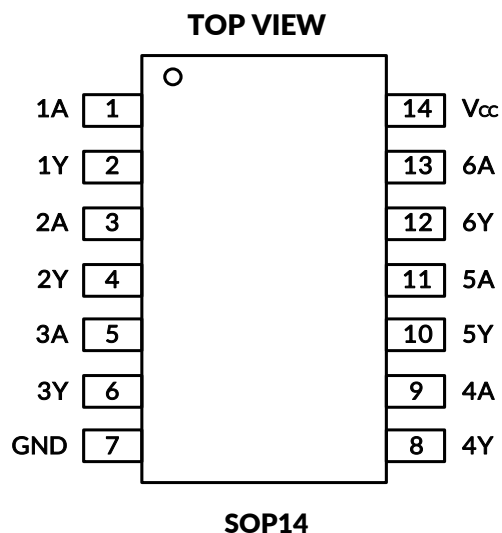

PIN DESCRIPTION

PIN	NAME	I/O TYPE ⁽¹⁾	FUNCTION
SOP14			
1	1A	I	Input 1
2	1Y	O	output 1
3	2A	I	Input 2
4	2Y	O	output 2
5	3A	I	Input 3
6	3Y	O	output 3
7	GND	P	Ground
8	4Y	O	output 4
9	4A	I	Input 4
10	5Y	O	output 5
11	5A	I	Input 5
12	6Y	O	output 6
13	6A	I	Input 6
14	Vcc	P	Power pin

(1) I=input, O=output, P=power.

8 SPECIFICATIONS

8.1 Absolute Maximum Ratings

over operating free-air temperature range (unless otherwise noted) ^{(1) (2)}

		MIN	MAX	UNIT
V _{CC}	Supply voltage range	-0.5	18	V
V _I	Input voltage range ⁽²⁾	-0.5	V _{CC} +0.5	V
V _O	Voltage range applied to any output in the high-impedance or power-off state ⁽²⁾	-0.5	18	V
V _O	Voltage range applied to any output in the high or low state ^{(2) (3)}	-0.5	V _{CC} +0.5	V
I _{IK}	Input clamp current	V _I <-0.5V	-50	mA
I _{OK}	Output clamp current	V _O <0 or V _O >V _{CC} +0.5V	±50	mA
I _O	Continuous output current		±25	mA
	Continuous current through V _{CC} or GND		±50	mA
θ _{JA}	Package thermal impedance ⁽⁴⁾	SOP14	105	°C/W
T _J	Junction temperature ⁽⁵⁾	-65	150	°C
T _{stg}	Storage temperature	-65	150	°C

- (1) Stresses beyond those listed under Absolute Maximum Ratings may cause permanent damage to the device. These are stress ratings only, and functional operation of the device at these or any other conditions beyond those indicated under Recommended Operating Conditions is not implied. Exposure to absolute-maximum-rated conditions for extended periods may affect device reliability.
- (2) The input and output negative-voltage ratings may be exceeded if the input and output current ratings are observed.
- (3) The value of V_{CC} is provided in the Recommended Operating Conditions table.
- (4) The package thermal impedance is calculated in accordance with JESD-51.
- (5) The maximum power dissipation is a function of T_{J(MAX)}, R_{θJA}, and T_A. The maximum allowable power dissipation at any ambient temperature is P_D = (T_{J(MAX)} - T_A) / R_{θJA}. All numbers apply for packages soldered directly onto a PCB.

8.2 ESD Ratings

The following ESD information is provided for handling of ESD-sensitive devices in an ESD protected area only.

		VALUE	UNIT
V _(ESD) Electrostatic discharge	Human-body model (HBM), MIL-STD-883K METHOD 3015.9	±2000	V
	Charged-device model (CDM), ANSI/ESDA/JEDEC JS-002-2018	±1000	V
	Machine model (MM), JESD22-A115C (2010)	±200	V



ESD SENSITIVITY CAUTION

ESD damage can range from subtle performance degradation to complete device failure. Precision integrated circuits may be more susceptible to damage because very small parametric changes could cause the device not to meet its published specifications.

9 ELECTRICAL CHARACTERISTICS

over recommended operating free-air temperature range (TYP values are at $T_A = +25^{\circ}\text{C}$, Full= -40°C to 125°C , unless otherwise noted.) ⁽¹⁾

9.1 Recommended Operating Conditions

PARAMETER	SYMBOL	TEST CONDITIONS	MIN	MAX	UNIT
Supply voltage	V_{CC}		3	15	V
High-level input voltage	V_{IH}	$V_{CC}=5\text{V}$	4		V
		$V_{CC}=10\text{V}$	8		
		$V_{CC}=15\text{V}$	12.5		
Low-level input voltage	V_{IL}	$V_{CC}=5\text{V}$		1	V
		$V_{CC}=10\text{V}$		2	
		$V_{CC}=15\text{V}$		2.5	
Input voltage	V_I		0	V_{CC}	V
Output voltage	V_O		0	V_{CC}	V
Operating temperature	T_A		-40	125	$^{\circ}\text{C}$

(1) All unused inputs of the device must be held at V_{CC} or GND to ensure proper device operation.

9.2 DC Characteristics

over recommended operating free-air temperature range (unless otherwise noted.)⁽¹⁾

PARAMETER		TEST CONDITIONS	V _{CC}	TEMP	MIN ⁽²⁾	TYP ⁽³⁾	MAX ⁽²⁾	UNIT
V _{OH}		I _{OH} = -100μA	5V	Full	4.95			V
		I _{OH} = -1mA			4.4			
		I _{OH} = -2mA			4			
		I _{OH} = -100μA	10V		9.95			
		I _{OH} = -1mA			9.5			
		I _{OH} = -3mA			9			
		I _{OH} = -100μA	15V		14.95			
		I _{OH} = -6mA			13.5			
V _{OL}		I _{OL} = 100μA	5V	Full			0.05	V
		I _{OL} = 1mA					0.4	
		I _{OL} = 2mA					0.6	
		I _{OL} = 100μA	10V				0.05	
		I _{OL} = 1mA					0.5	
		I _{OL} = 3mA					1	
		I _{OL} = 100μA	15V				0.05	
		I _{OL} = 6mA					1.5	
I _I	A input	V _I =15V or GND	15V	25°C		±0.1	±1	μA
				Full			±2	
I _{CC}		V _I =V _{CC} or GND, I _O =0A	5V	25°C		0.1	1	μA
				Full			5	
			10V	25°C		0.5	1	μA
				Full			15	
			15V	25°C		1	1.5	μA
				Full			20	

(1) All unused inputs of the device must be held at V_{CC} or GND to ensure proper device operation.

(2) Limits are 100% production tested at 25°C. Limits over the operating temperature range are ensured through correlations using statistical quality control (SQC) method.

(3) Typical values represent the most likely parametric norm as determined at the time of characterization. Actual typical values may vary over time and will also depend on the application and configuration.

9.3 AC Characteristics

PARAMETER	SYMBOL	TEST CONDITIONS	TEMP	MIN ⁽²⁾	TYP ⁽³⁾	MAX ⁽²⁾	UNIT
Propagation Delay	t_{pd}	$V_{CC}=5V, C_L=50pF$	Full		38	57	ns
		$V_{CC}=10V, C_L=50pF$			24	36	
		$V_{CC}=15V, C_L=50pF$			19	28.5	
LOW to HIGH output transition time	t_r	$V_{CC}=5V, C_L=50pF$	Full		65	97.5	ns
		$V_{CC}=10V, C_L=50pF$			37	55.5	
		$V_{CC}=15V, C_L=50pF$			25	37.5	
HIGH to LOW output transition time	t_f	$V_{CC}=5V, C_L=50pF$	Full		54	81	ns
		$V_{CC}=10V, C_L=50pF$			34	51	
		$V_{CC}=15V, C_L=50pF$			26	39	
Input Capacitance	C_i	$V_{CC}=5V$	25°C		4		pF
Power dissipation capacitance per out	C_{pd}	$V_{CC}=5V$	f=10MHz	25°C		4.5	pF
		$V_{CC}=10V$				5.5	
		$V_{CC}=15V$				6	

(1) All unused inputs of the device must be held at V_{CC} or GND to ensure proper device operation.

(2) This parameter is ensured by design and/or characterization and is not tested in production.

(3) Typical values represent the most likely parametric norm as determined at the time of characterization. Actual typical values may vary over time and will also depend on the application and configuration.

9.4 Typical Performance Characteristics

NOTE: The graphs and tables provided following this note are a statistical summary based on a limited number of samples and are provided for informational purposes only.

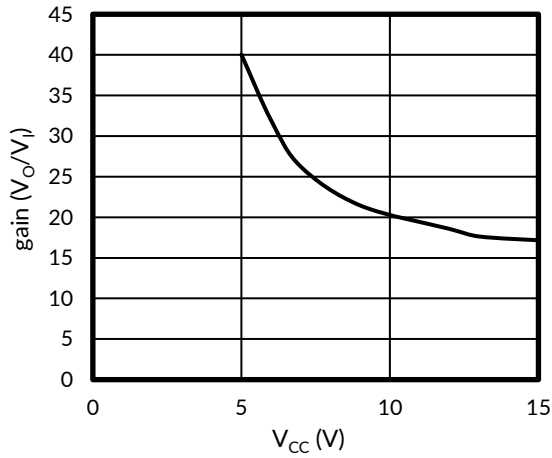

Figure 1. Typical voltage gain as a function of supply voltage

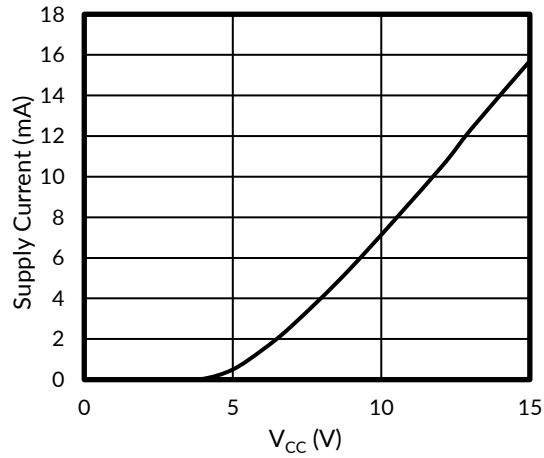

Figure 2. Typical supply current as a function of supply voltage

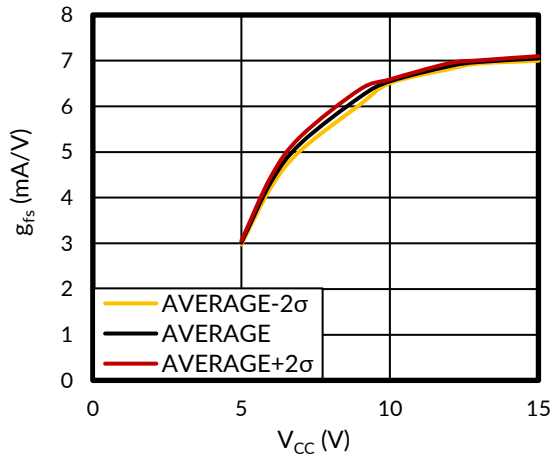

Figure 3. Typical forward transconductance as a function of supply voltage at T_{amb}=25°C

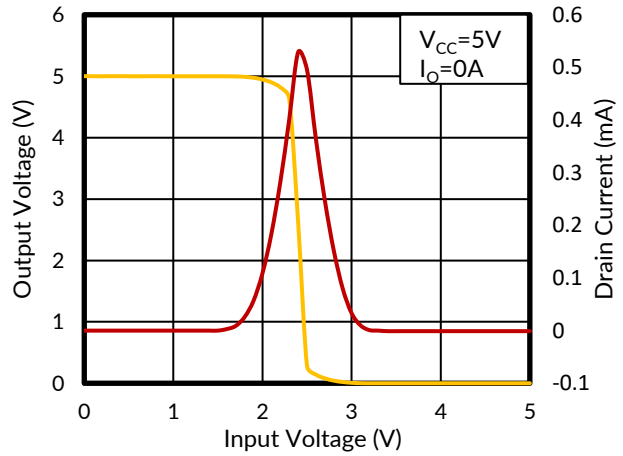

Figure 4. Typical transfer characteristics

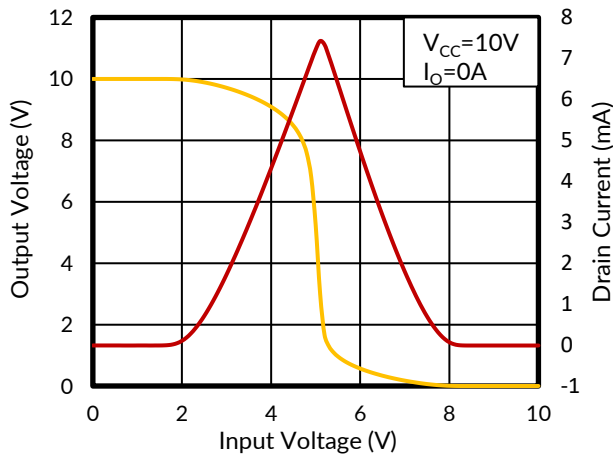

Figure 5. Typical transfer characteristics

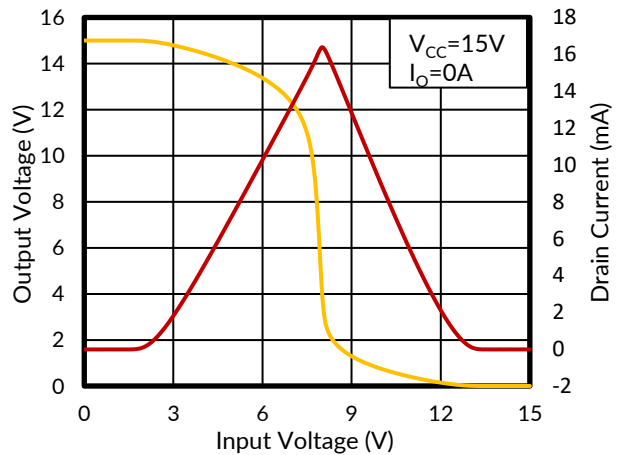
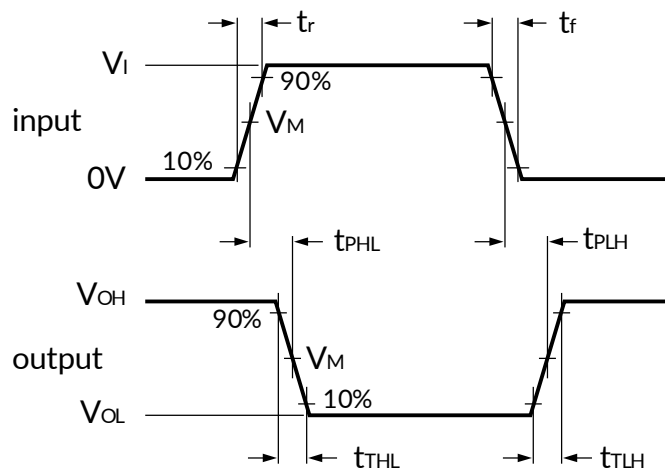

Figure 6. Typical transfer characteristics

10 WAVEFORMS AND TEST CIRCUIT



Measurement points are given in Table 1.

Logic levels: V_{OL} and V_{OH} are typical output voltage levels that occur with the output load.

t_r , t_f = input rise and fall times.

Figure 7. Propagation delay and output transition time

Table 1. Measurement points

Supply voltage	Input	Output
V_{CC}	V_M	V_M
5 V to 15 V	$0.5 V_{CC}$	$0.5 V_{CC}$

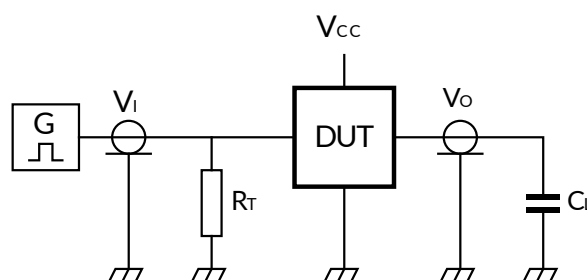

Test data given in Table 2.

Definitions for test circuit:

C_L = load capacitance including jig and probe capacitance.

R_T = termination resistance should be equal to the output impedance Z_o of the pulse generator.

Figure 8. Test circuit for measuring switching times

Table 2. Test data

Supply voltage	Input		Load
V_{CC}	V_I	t_r , t_f	C_L
5 V to 15 V	V_{CC} or GND	≤ 20 ns	50 pF

11 PACKAGE OUTLINE DIMENSIONS

SOP14 ⁽³⁾

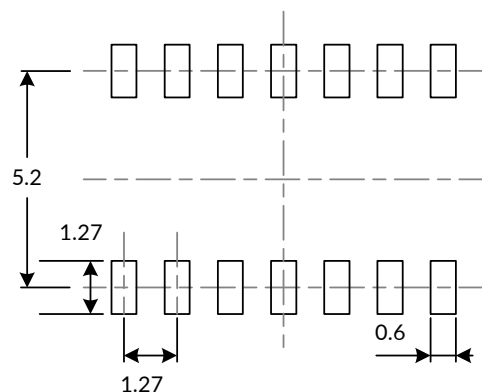
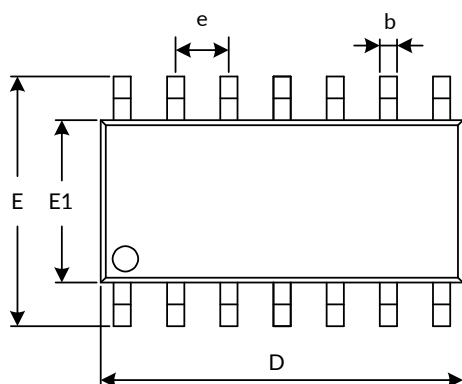

RECOMMENDED LAND PATTERN (Unit: mm)

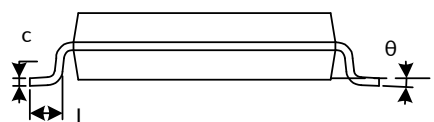
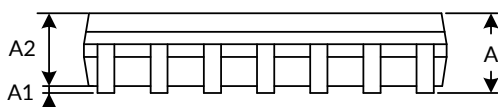

Symbol	Dimensions In Millimeters		Dimensions In Inches	
	Min	Max	Min	Max
A ⁽¹⁾		1.750		0.069
A1	0.100	0.250	0.004	0.010
A2	1.300	1.500	0.051	0.059
b	0.390	0.470	0.015	0.019
c	0.200	0.240	0.008	0.009
D ⁽¹⁾	8.550	8.750	0.336	0.344
e	1.270(BSC) ⁽²⁾		0.050(BSC) ⁽²⁾	
E	5.800	6.200	0.228	0.244
E1 ⁽¹⁾	3.800	4.000	0.150	0.157
L	0.500	0.800	0.020	0.031
θ	0°	8°	0°	8°

NOTE:

1. Plastic or metal protrusions of 0.15mm maximum per side are not included.
2. BSC (Basic Spacing between Centers), "Basic" spacing is nominal.
3. This drawing is subject to change without notice.

12 TAPE AND REEL INFORMATION

REEL DIMENSIONS

TAPE DIMENSION

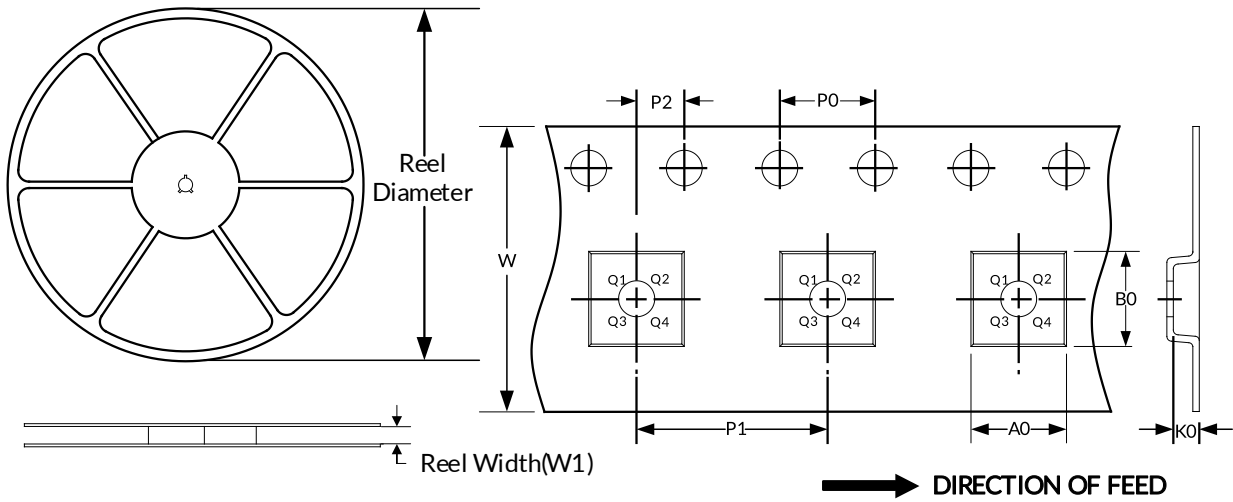

NOTE: The picture is only for reference. Please make the object as the standard.

KEY PARAMETER LIST OF TAPE AND REEL

Package Type	Reel Diameter	Reel Width(mm)	A0 (mm)	B0 (mm)	K0 (mm)	P0 (mm)	P1 (mm)	P2 (mm)	W (mm)	Pin1 Quadrant
SOP14	13"	16.4	6.60	9.30	2.10	4.0	8.0	2.0	16.0	Q1

NOTE:

1. All dimensions are nominal.
2. Plastic or metal protrusions of 0.15mm maximum per side are not included.

IMPORTANT NOTICE AND DISCLAIMER

Jiangsu Runic Technology Co., Ltd. will accurately and reliably provide technical and reliability data (including data sheets), design resources (including reference designs), application or other design advice, WEB tools, safety information and other resources, without warranty of any defect, and will not make any express or implied warranty, including but not limited to the warranty of merchantability Implied warranty that it is suitable for a specific purpose or does not infringe the intellectual property rights of any third party.

These resources are intended for skilled developers designing with Runic products You will be solely responsible for: (1) Selecting the appropriate products for your application; (2) Designing, validating and testing your application; (3) Ensuring your application meets applicable standards and any other safety, security or other requirements; (4) Runic and the Runic logo are registered trademarks of Runic Incorporated. All trademarks are the property of their respective owners; (5) For change details, review the revision history included in any revised document. The resources are subject to change without notice. Our company will not be liable for the use of this product and the infringement of patents or third-party intellectual property rights due to its use.