

500mA, Low Quiescent Current, Low-Noise, High PSRR, Low-Dropout Linear Regulator

1 FEATURES

- **Input voltage range: 1.9 V to 5.5 V**
- **Output voltage range: 1.2 V to 4.5 V**
- **Up to 500mA load current**
- **Very low I_q: 16μA(typical)**
- **Very high PSRR: 81dB at 1kHz**
- **Ultra low noise: 13uVrms at 1.8V output**
- **No noise bypass capacitor required**
- **Excellent load/line transient response**
- **Short circuit protection is typical 55mA**
- **With auto discharge function**
- **Output Voltage Accuracy: ±1%/±1.5%**
- **Micro Size Packages: SOT23-5, XDFN1X1-4**

2 APPLICATIONS

- **Smart Phones and Cellular Phones**
- **PDA's**
- **MP3/MP4 Player**
- **Digital Still Cameras**
- **Portable instrument**

3 DESCRIPTIONS

The RS3217 is a low-noise LDO that can supply up to 500mA output current. Designed to meet the requirements of RF and analog circuits, the RS3217 device provides low noise, high PSRR, low quiescent current, and low line or load transient response figures.

RS3217 is stable with a 1.0μF ceramic input and output capacitor, Using the new innovative design techniques, the RS3217 offers class-leading noise performance without a noise bypass capacitor.

RS3217 is available with fixed output voltages from 1.2V to 4.5V.

RS3217 is offered in a small SOT23-5 and XDFN1X1-4 packages, which is ideal for small form factor portable equipment.

Device Information ⁽¹⁾

PART NUMBER	PACKAGE	BODY SIZE (NOM)
RS3217	SOT23-5	1.60mm×2.92mm
	XDFN1X1-4	1.00mm×1.00mm

⁽¹⁾ For all available packages, see the orderable addendum at the end of the data sheet.

Typical Application

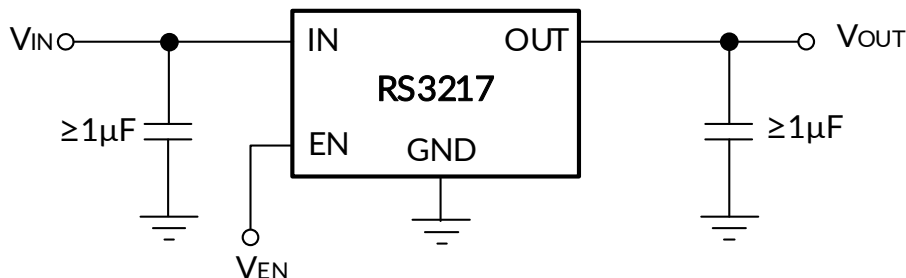

4 FUNCTIONAL BLOCK DIAGRAM

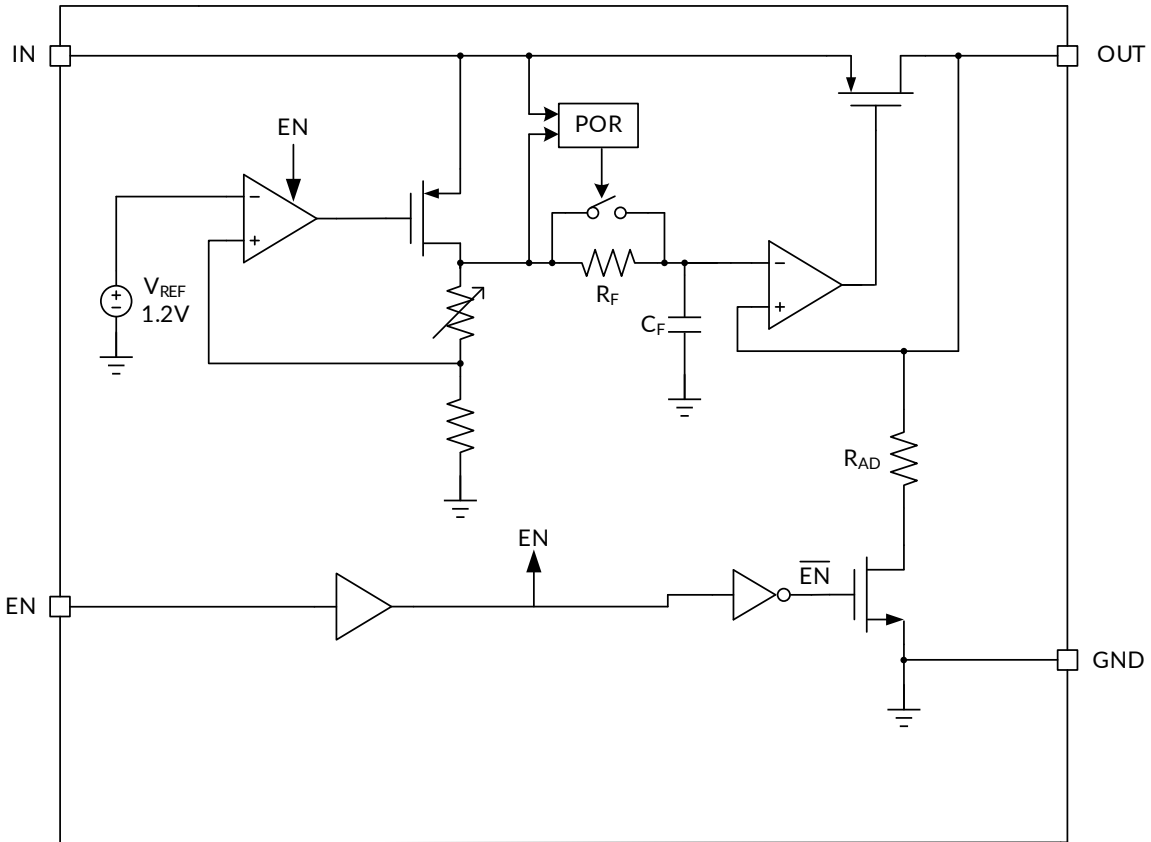

(1) The 1.2V fixed voltage version has a 1V bandgap instead of a 1.2V circuit.

Table of Contents

1 FEATURES	1
2 APPLICATIONS	1
3 DESCRIPTIONS	1
4 FUNCTIONAL BLOCK DIAGRAM	2
5 REVISION HISTORY	4
6 PACKAGE/ORDERING INFORMATION ⁽¹⁾	5
7 PIN CONFIGURATION AND FUNCTIONS	6
8 SPECIFICATIONS	7
8.1 Absolute Maximum Ratings	7
8.2 ESD Ratings	7
8.3 Recommended Operating Conditions	7
8.4 ELECTRICAL CHARACTERISTICS	8
8.5 TYPICAL PERFORMANCE CHARACTERISTICS	10
9 FEATURE DESCRIPTION	16
9.1 Overview	16
9.2 Shutdown	16
9.3 Output Automatic Discharge	16
9.4 Thermal Overload Protection (T _{SD})	16
9.5 Current-Limit Protection	16
9.6 Short Current-Limit Protection	16
10 TYPICAL APPLICATION	17
10.1 Input and Output Capacitor Requirements	17
11 POWER SUPPLY RECOMMENDATIONS	17
12 LAYOUT	17
13 PACKAGE OUTLINE DIMENSIONS	18
14 TAPE AND REEL INFORMATION	20

5 REVISION HISTORY

Note: Page numbers for previous revisions may differ from page numbers in the current version.

VERSION	Change Date	Change Item
A.0	2023/12/08	Preliminary version completed
A.0.1	2024/04/02	1. Update Operating Ambient Temperature Range 2. Update ELECTRICAL CHARACTERISTICS 3. Update TYPICAL PERFORMANCE CHARACTERISTICS
A.1	2024/07/17	1. Update ELECTRICAL CHARACTERISTICS 2. Added RS3217-1.35 Orderable Device

6 PACKAGE/ORDERING INFORMATION (1)

Orderable Device	V _{OUT} (V)	Package Type	Op Temp(°C)	Device Marking (2)	MSL (3)	Package Qty
RS3217-1.2XF5	1.2	SOT23-5	-40°C ~125°C	LE12	MSL3	Tape and Reel,3000
RS3217-1.35XF5	1.35	SOT23-5	-40°C ~125°C	LE135	MSL3	Tape and Reel,3000
RS3217-1.5XF5	1.5	SOT23-5	-40°C ~125°C	LE15	MSL3	Tape and Reel,3000
RS3217-1.8XF5	1.8	SOT23-5	-40°C ~125°C	LE18	MSL3	Tape and Reel,3000
RS3217-2.5XF5	2.5	SOT23-5	-40°C ~125°C	LE25	MSL3	Tape and Reel,3000
RS3217-2.8XF5	2.8	SOT23-5	-40°C ~125°C	LE28	MSL3	Tape and Reel,3000
RS3217-2.9XF5	2.9	SOT23-5	-40°C ~125°C	LE29	MSL3	Tape and Reel,3000
RS3217-3.0XF5	3.0	SOT23-5	-40°C ~125°C	LE30	MSL3	Tape and Reel,3000
RS3217-3.2XF5	3.2	SOT23-5	-40°C ~125°C	LE32	MSL3	Tape and Reel,3000
RS3217-3.3XF5	3.3	SOT23-5	-40°C ~125°C	LE33	MSL3	Tape and Reel,3000
RS3217-3.6XF5	3.6	SOT23-5	-40°C ~125°C	LE36	MSL3	Tape and Reel,3000
RS3217-4.0XF5	4.0	SOT23-5	-40°C ~125°C	LE40	MSL3	Tape and Reel,3000
RS3217-4.5XF5	4.5	SOT23-5	-40°C ~125°C	LE45	MSL3	Tape and Reel,3000
RS3217-1.2XUTDN4	1.2	XDFN1X1-4	-40°C ~125°C	EA	MSL3	Tape and Reel,10000
RS3217-1.35XUTDN4	1.35	XDFN1X1-4	-40°C ~125°C	EN	MSL3	Tape and Reel,10000
RS3217-1.5XUTDN4	1.5	XDFN1X1-4	-40°C ~125°C	EB	MSL3	Tape and Reel,10000
RS3217-1.8XUTDN4	1.8	XDFN1X1-4	-40°C ~125°C	EC	MSL3	Tape and Reel,10000
RS3217-2.5XUTDN4	2.5	XDFN1X1-4	-40°C ~125°C	ED	MSL3	Tape and Reel,10000
RS3217-2.8XUTDN4	2.8	XDFN1X1-4	-40°C ~125°C	EE	MSL3	Tape and Reel,10000
RS3217-2.9XUTDN4	2.9	XDFN1X1-4	-40°C ~125°C	EF	MSL3	Tape and Reel,10000
RS3217-3.0XUTDN4	3.0	XDFN1X1-4	-40°C ~125°C	EG	MSL3	Tape and Reel,10000
RS3217-3.2XUTDN4	3.2	XDFN1X1-4	-40°C ~125°C	EH	MSL3	Tape and Reel,10000
RS3217-3.3XUTDN4	3.3	XDFN1X1-4	-40°C ~125°C	EJ	MSL3	Tape and Reel,10000
RS3217-3.6XUTDN4	3.6	XDFN1X1-4	-40°C ~125°C	EK	MSL3	Tape and Reel,10000
RS3217-4.0XUTDN4	4.0	XDFN1X1-4	-40°C ~125°C	EL	MSL3	Tape and Reel,10000
RS3217-4.5XUTDN4	4.5	XDFN1X1-4	-40°C ~125°C	EM	MSL3	Tape and Reel,10000

NOTE:

- (1) This information is the most current data available for the designated devices. This data is subject to change without notice and revision of this document. For browser-based versions of this data sheet, refer to the right-hand navigation.
- (2) There may be additional marking, which relates to the lot trace code information (data code and vendor code), the logo or the environmental category on the device.
- (3) RUNIC classify the MSL level with using the common preconditioning setting in our assembly factory conforming to the JEDEC industrial standard J-STD-20F, Please align with RUNIC if your end application is quite critical to the preconditioning setting or if you have special requirement.

7 PIN CONFIGURATION AND FUNCTIONS

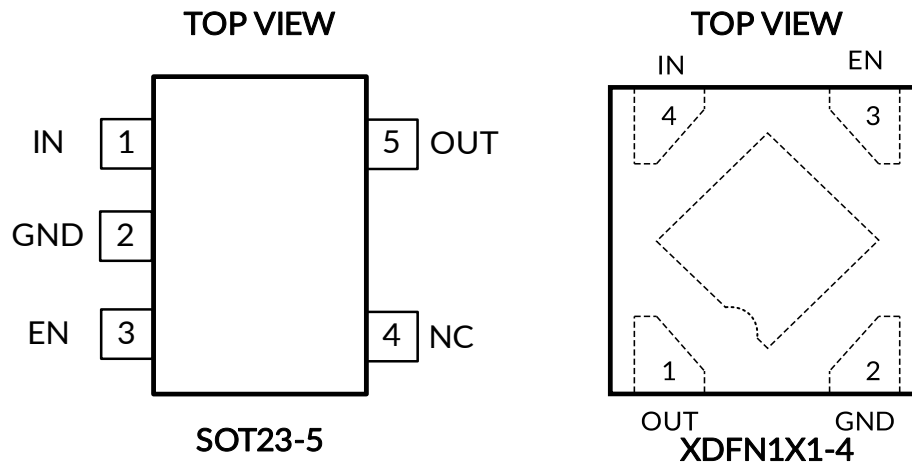

Pin Description

NAME	PIN		I/O ⁽¹⁾	DESCRIPTION
	SOT23-5	XDFN1X1-4		
IN	1	4	I	Input voltage supply. Must be closely decoupled to GND with a 1 μ F or greater capacitor.
GND	2	2	G	Common ground.
EN	3	3	I	Enable input. A low voltage (< V_{IL}) on this pin turns the regulator off and discharges the output pin to GND through an internal pulldown resistor. A high voltage (> V_{IH}) on this pin enables the regulator output. The EN pin can be connected to the IN pin if not used. Do not leave floating.
NC	4	-	-	Not internally connected.
OUT	5	1	O	Regulated output voltage. Connect a minimum 1 μ F low-ESR capacitor to this pin.
-	-	Thermal Pad	-	Connect the thermal pad to a large-area ground plane. This pad is not an electrical connection to the device ground.

(1) I=input, O=output, G= Ground.

8 SPECIFICATIONS

8.1 Absolute Maximum Ratings

over operating free-air temperature range (unless otherwise noted) ⁽¹⁾ ⁽²⁾

		MIN	MAX	UNIT
V _{IN}	Input voltage	-0.3	6	V
V _{EN}	Enable input voltage	-0.3	6	V
V _{OUT}	Output voltage	-0.3	V _{IN} + 0.3	V
I _{OUT}	Maximum Load Current	Internally limited		mA
θ _{JA}	Package thermal impedance ⁽³⁾	SOT23-5	200	°C/W
		XDFN1X1-4	315	
T _J	Junction temperature ⁽⁴⁾	-40	125	°C
T _{stg}	Storage temperature	-65	150	°C
	Load Temperature (Soldering, 10sec)		260	°C

- (1) Stresses beyond those listed under Absolute Maximum Ratings may cause permanent damage to the device. These are stress ratings only, and functional operation of the device at these or any other conditions beyond those indicated under Recommended Operating Conditions is not implied. Exposure to absolute-maximum-rated conditions for extended periods may affect device reliability.
- (2) All voltages are with respect to the GND pin.
- (3) The package thermal impedance is calculated in accordance with JESD-51.
- (4) The maximum power dissipation is a function of T_{J(MAX)}, R_{θJA}, and T_A. The maximum allowable power dissipation at any ambient temperature is P_D = (T_{J(MAX)} - T_A) / R_{θJA}. All numbers apply for packages soldered directly onto a PCB.

8.2 ESD Ratings

The following ESD information is provided for handling of ESD-sensitive devices in an ESD protected area only.

			VALUE	UNIT
V _(ESD)	Electrostatic discharge	Human-Body Model (HBM), MIL-STD-883K METHOD 3015.9	±4000	V
		Charged-Device Model (CDM), ANSI/ESDA/JEDEC JS-002-2018	±1500	



ESD SENSITIVITY CAUTION

ESD damage can range from subtle performance degradation to complete device failure. Precision integrated circuits may be more susceptible to damage because very small parametric changes could cause the device not to meet its published specifications.

8.3 Recommended Operating Conditions

over operating free-air temperature range (unless otherwise noted)

		MIN	MAX	UNIT
V _{IN}	Input Voltage Range on IN	1.9	5.5	V
V _{OUT}	Output Voltage Range on OUT	1.2	4.5	V
V _{EN}	Input Voltage Range on EN	0	5.5	V
I _{OUT}	Output Current Range on IOUT	0	500	mA
T _A	Operating Ambient Temperature Range	-40	125	°C

8.4 ELECTRICAL CHARACTERISTICS

Over operating temperature range ($-40^{\circ}\text{C} \leq T_J \leq 125^{\circ}\text{C}$). $V_{\text{OUT}}=1.8\text{V}$, $V_{\text{IN}}=V_{\text{OUTNOM}}+1\text{V}$, $V_{\text{EN}}=1.2\text{V}$, $I_{\text{OUT}}=1\text{mA}$, $C_{\text{IN}}=1\mu\text{F}$, $C_{\text{OUT}}=1\mu\text{F}$. Typical values are at $T_A = 25^{\circ}\text{C}$.

PARAMETER	SYMBOL	CONDITIONS	MIN	TYP	MAX	UNIT	
POWER SUPPLY AND CURRENTS							
Input Voltage ⁽¹⁾	V_{IN}		1.9		5.5	V	
Quiescent Current	I_{Q}	$V_{\text{EN}}=1.2\text{V}$, $I_{\text{OUT}}=0\text{mA}$		16	25	μA	
Ground Pin Current	I_{GND}	$V_{\text{EN}}=1.2\text{V}$, $I_{\text{OUT}}=500\text{mA}$		275		μA	
Shutdown Current	I_{SD}	$V_{\text{EN}} = 0\text{V}$		0.01	1	μA	
OUTPUT VOLTAGE							
Output Voltage Range	V_{OUT}		1.2		4.5	V	
DC Output Accuracy ⁽¹⁾	ΔV_{OUT}	$T_J = 25^{\circ}\text{C}$	-1.5		1.5	%	
		$T_J = 25^{\circ}\text{C}$, RS3217-xxA	-1		1	%	
Line Regulation ⁽¹⁾	$\Delta V_{\text{OUT}}(\Delta V_{\text{IN}})$	$V_{\text{IN}}=2.8$ to 5.5V , $I_{\text{OUT}}=1\text{mA}$		0.005	0.05	%/V	
Load Regulation	$\Delta V_{\text{OUT}}(\Delta I_{\text{OUT}})$	$I_{\text{OUT}}=1\text{mA}$ to 500mA		3	6	mV	
Output Voltage Temperature Coefficient	$\frac{\Delta V_{\text{OUT}}}{\Delta T_A \times V_{\text{OUT}}}$	$I_{\text{OUT}} = 1\text{mA}$, $T_J = -40^{\circ}\text{C} \sim 85^{\circ}\text{C}$		30		ppm/ $^{\circ}\text{C}$	
		$I_{\text{OUT}} = 1\text{mA}$, $T_J = -40^{\circ}\text{C} \sim 125^{\circ}\text{C}$		70		ppm/ $^{\circ}\text{C}$	
Maximum output current	I_{OUTMAX}		500			mA	
Output discharge FET R_{dson}	R_{DIS}	$V_{\text{EN}} < V_{\text{IL}}$ (output disable), $V_{\text{IN}}=2.8\text{V}$	40	70	90	Ω	
Line transient	$\Delta V_{\text{OUT}}^{(3)}$	$V_{\text{IN}}=2.8$ to 5.5V in $30\mu\text{s}$		1		mV	
		$V_{\text{IN}}=5.5$ to 2.8V in $30\mu\text{s}$		1		mV	
$I_{\text{OUT}}=1\text{mA}$ to 500mA in $10\mu\text{s}$			25			mV	
$I_{\text{OUT}}=500\text{mA}$ to 1mA in $10\mu\text{s}$			20			mV	
Load transient							
Overshoot on start-up		Stated as percentage of $V_{\text{OUT(NOM)}}$		0.1		%	
DROPOUT VOLTAGE							
Dropout Voltage ⁽²⁾	V_{DO}	$I_{\text{OUT}}=500\text{mA}$	$V_{\text{OUT}}=1.2\text{V}$		700	1000	mV
			$V_{\text{OUT}}=1.8\text{V}$		345	390	
			$V_{\text{OUT}}=2.8\text{V}$		245	285	
			$V_{\text{OUT}}=3.3\text{V}$		220	255	
POWER SUPPLY REJECTION RATIO AND NOISE							
Power Supply Rejection Ratio	PSRR ⁽³⁾	$f=100\text{Hz}$, $I_{\text{OUT}}=20\text{mA}$		83		dB	
		$f=1\text{kHz}$, $I_{\text{OUT}}=20\text{mA}$		81		dB	
		$f=10\text{kHz}$, $I_{\text{OUT}}=20\text{mA}$		70		dB	
		$f=100\text{kHz}$, $I_{\text{OUT}}=20\text{mA}$		55		dB	
Output Noise Voltage	$V_{\text{N}}^{(3)}$	$\text{BW}=10\text{Hz}$ to 100kHz , $I_{\text{OUT}}=1\text{mA}$		16		μV_{RMS}	
		$\text{BW}=10\text{Hz}$ to 100kHz , $I_{\text{OUT}}=500\text{mA}$		13		μV_{RMS}	
ENABLE AND STARTUP TIME							
EN Input Logic High Voltage	V_{IH}	$V_{\text{IN}} = 1.9\text{V}$ to 5.5V , V_{EN} rising until the output is enabled	1.2			V	
EN Input Logic Low Voltage	V_{IL}	$V_{\text{IN}} = 1.9\text{V}$ to 5.5V , V_{EN} falling until the output is disabled			0.4	V	

EN Input leakage current	I_{EN}	$V_{IN}=5.5, V_{EN} = 0V$		0.001	0.1	μA
		$V_{IN}=5.5, V_{EN} = 5.5V$		0.4	1	μA
Output Turn-on Delay Time	T_{ON}	From $V_{EN} > V_{IH}$ to $V_{OUT} = 95\%$ of $V_{OUT(NOM)}$		60	150	μs
PROTECTIONS						
Over Current Limit	I_{LMT}		600	1100	1300	mA
Short Current Limit	I_{SHORT}	$V_{OUT}=0V$	25	55	100	mA
Thermal shutdown threshold	$T_{TSD}^{(3)}$	$V_{IN}=2.8V, T_J$ rising		165		$^{\circ}C$
Thermal shutdown hysteresis	$T_{HYS}^{(3)}$	$V_{IN}=2.8V, T_J$ falling from shutdown		15		$^{\circ}C$

NOTES:

- (1) Minimum $V_{IN} = V_{OUT} + V_{DO}$ or 1.9V, whichever is greater.
- (2) V_{DROP} FT test method: test the V_{OUT} voltage at $V_{SET} + V_{DROPMAX}$ with output current.
- (3) Guaranteed by design and characterization, not a FT item.

8.5 TYPICAL PERFORMANCE CHARACTERISTICS

NOTE: The graphs and tables provided following this note are a statistical summary based on a limited number of samples and are provided for informational purposes only.

$V_{IN} = 2.8V$, $I_{OUT} = 1mA$, $C_{IN} = \text{Ceramic } 1.0\mu F$, $C_{OUT} = \text{Ceramic } 1.0\mu F$, unless otherwise noted.

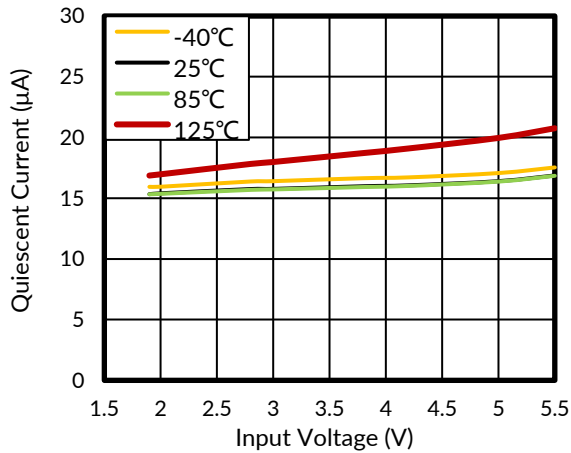

Figure 1. Quiescent Current vs Input Voltage

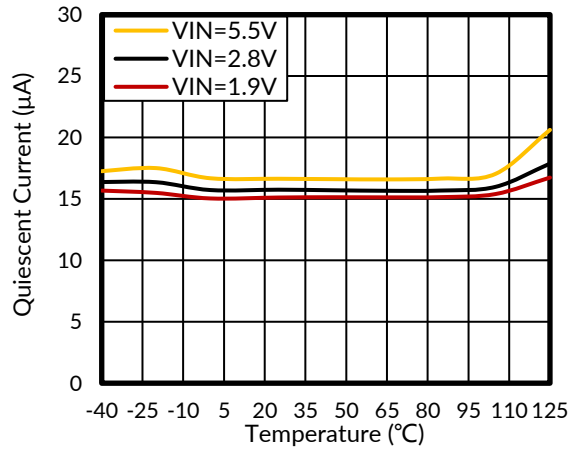

Figure 2. Quiescent Current vs Junction Temperature

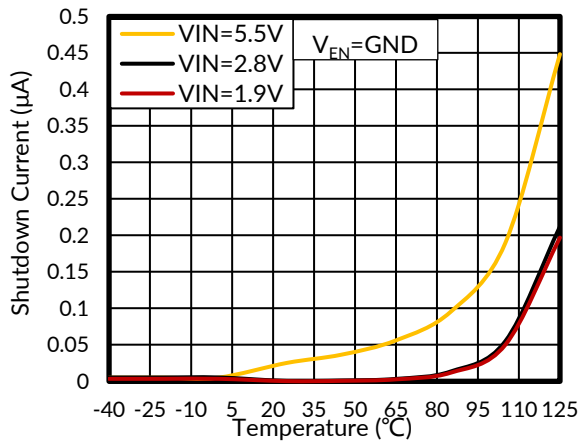

Figure 3. Shutdown Current vs Junction Temperature

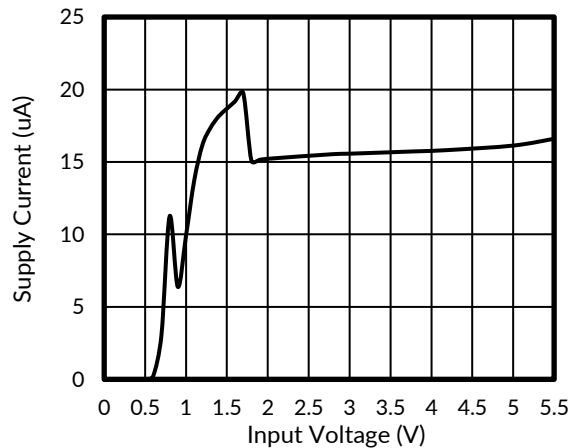

Figure 4. Supply Current vs Input Voltage

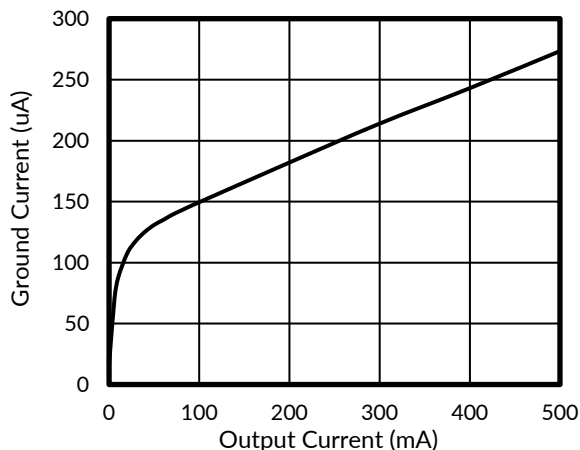

Figure 5. Ground Current vs Output Current

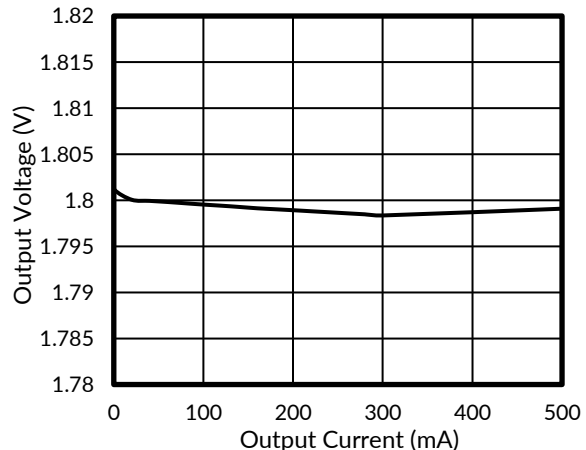

Figure 6. Load Regulation

TYPICAL PERFORMANCE CHARACTERISTICS

NOTE: The graphs and tables provided following this note are a statistical summary based on a limited number of samples and are provided for informational purposes only.

$V_{IN} = 2.8V$, $I_{OUT} = 1mA$, $C_{IN} = \text{Ceramic } 1.0\mu F$, $C_{OUT} = \text{Ceramic } 1.0\mu F$, unless otherwise noted.

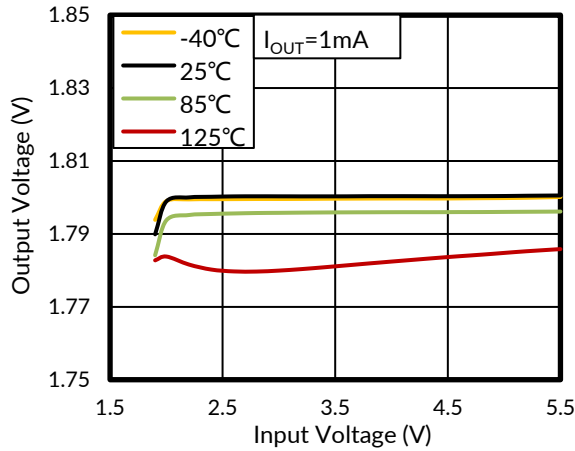

Figure 7. Line Regulation

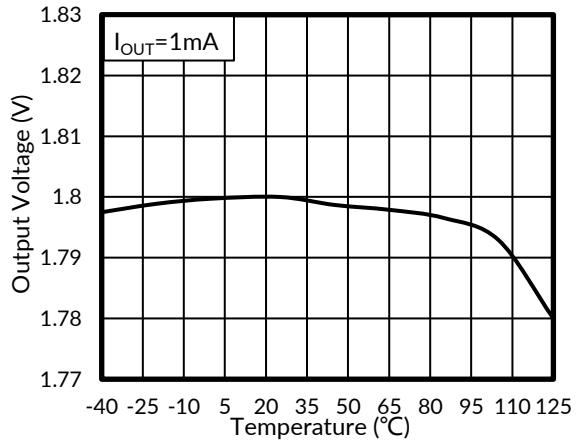

Figure 8. Output Voltage vs Junction Temperature

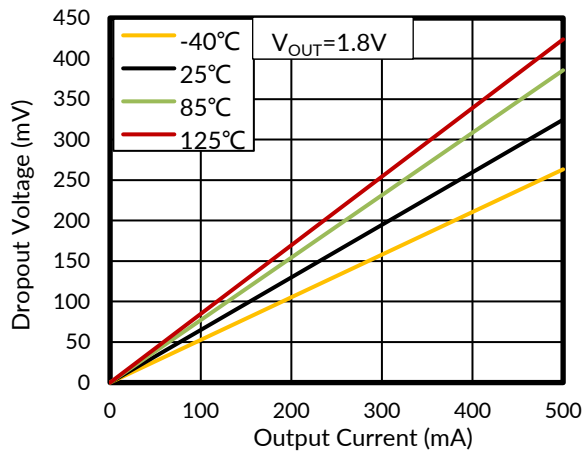

Figure 9. Dropout Voltage vs Output Current

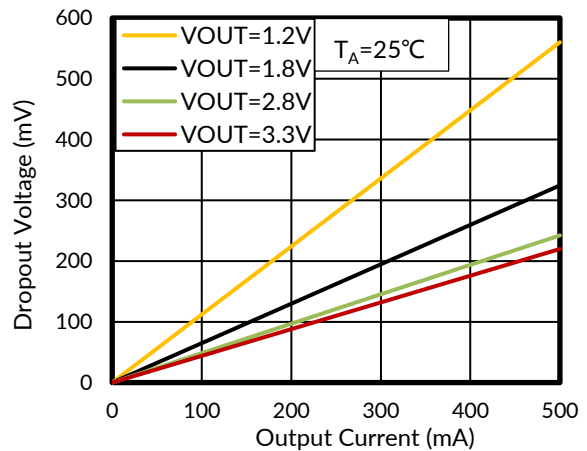

Figure 10. Dropout Voltage vs Output Current

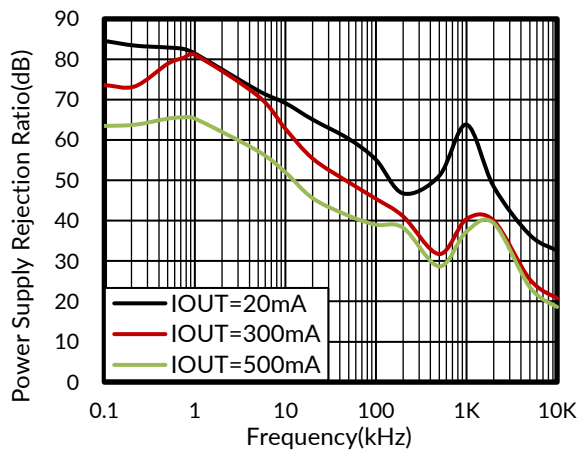

Figure 11. Power Supply Rejection Ratio vs Frequency

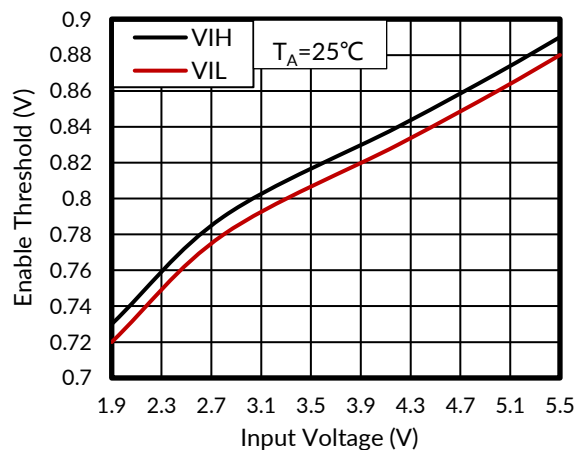

Figure 12. Enable Threshold vs Input Voltage

TYPICAL PERFORMANCE CHARACTERISTICS

NOTE: The graphs and tables provided following this note are a statistical summary based on a limited number of samples and are provided for informational purposes only.

$V_{IN} = 2.8V$, $I_{OUT} = 1mA$, $C_{IN} = \text{Ceramic } 1.0\mu F$, $C_{OUT} = \text{Ceramic } 1.0\mu F$, unless otherwise noted.

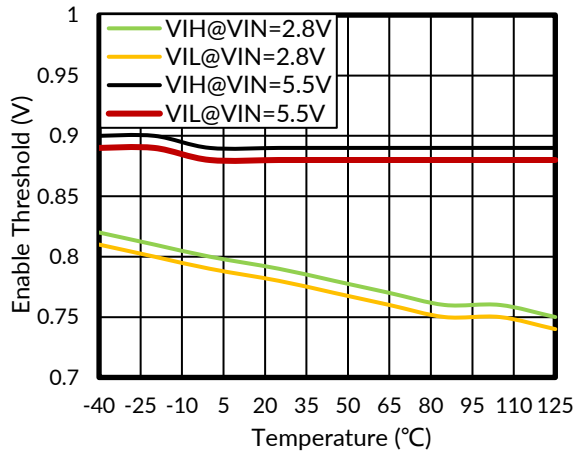

Figure 13. Enable Threshold vs Junction Temperature

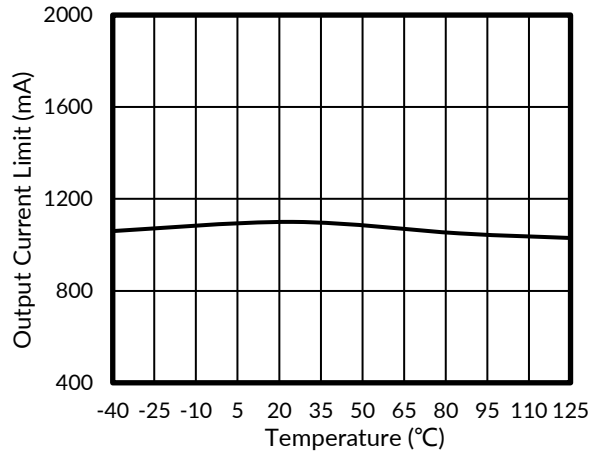

Figure 14. Output Current Limit vs Temperature

TYPICAL PERFORMANCE CHARACTERISTICS

NOTE: The graphs and tables provided following this note are a statistical summary based on a limited number of samples and are provided for informational purposes only.

$V_{IN} = 2.8V$, $I_{OUT} = 1mA$, $C_{IN} = \text{Ceramic } 1.0\mu F$, $C_{OUT} = \text{Ceramic } 1.0\mu F$, unless otherwise noted.

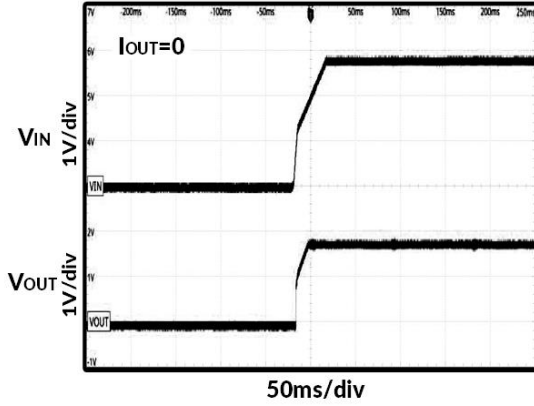

Figure 15. Power On

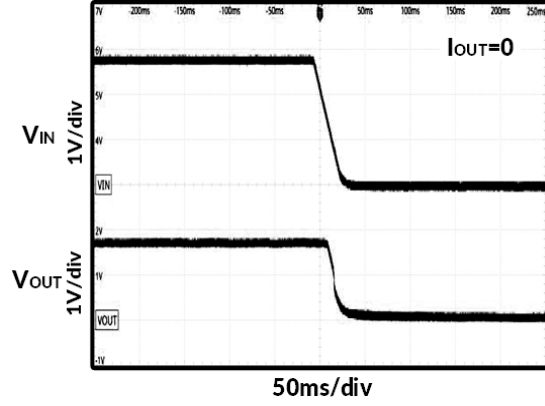

Figure 16. Power Off

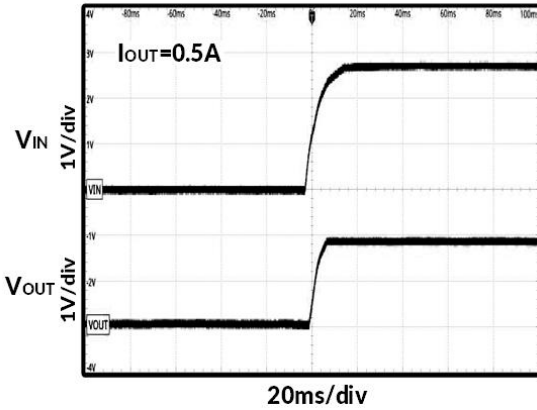

Figure 17. Power On

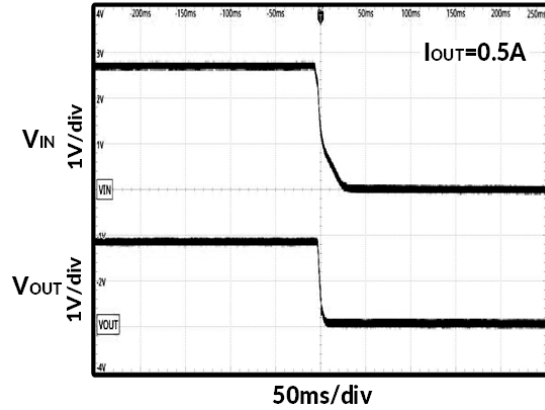

Figure 18. Power Off

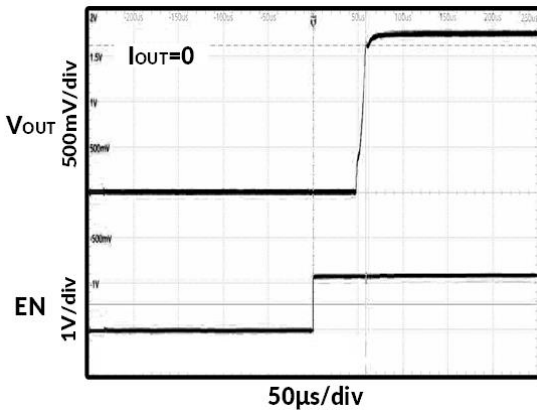

Figure 19. Turn On

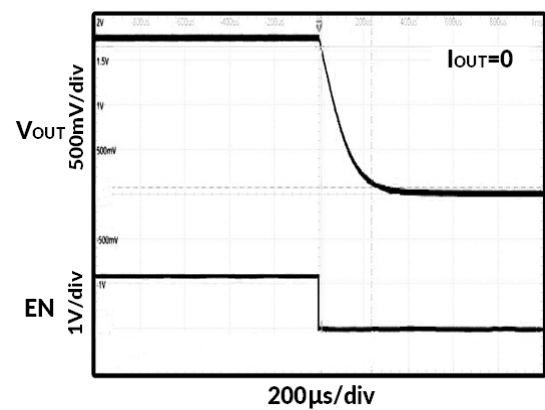

Figure 20. Turn Off

TYPICAL PERFORMANCE CHARACTERISTICS

NOTE: The graphs and tables provided following this note are a statistical summary based on a limited number of samples and are provided for informational purposes only.

$V_{IN} = 2.8V$, $I_{OUT} = 1mA$, $C_{IN} = \text{Ceramic } 1.0\mu F$, $C_{OUT} = \text{Ceramic } 1.0\mu F$, unless otherwise noted.

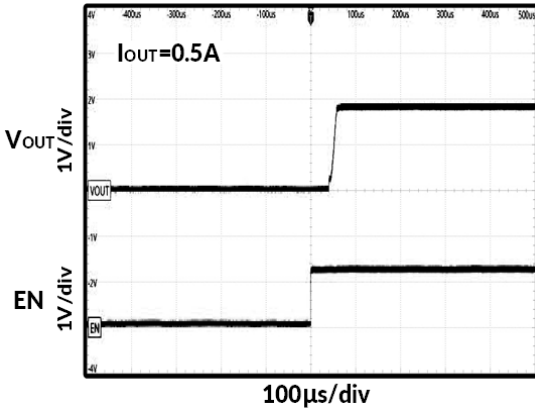

Figure 21. Turn On

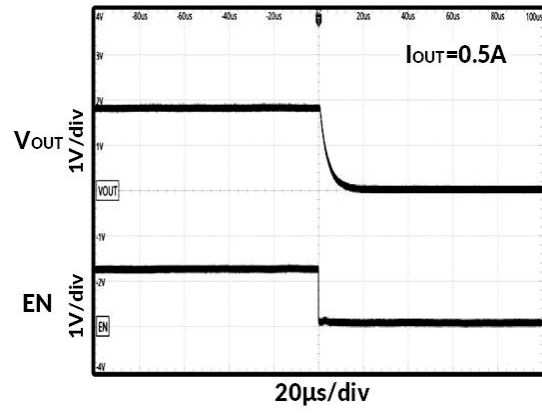

Figure 22. Turn Off

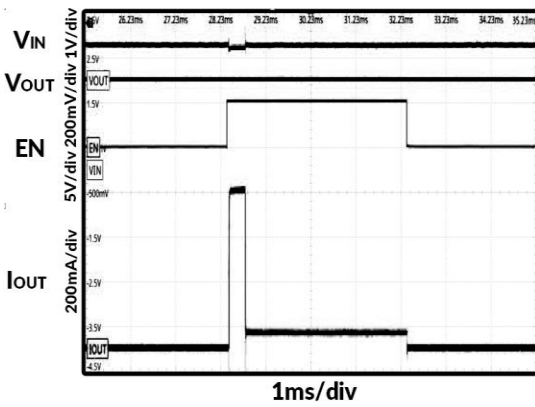

Figure 23. Short Circuit First, Then Turn On

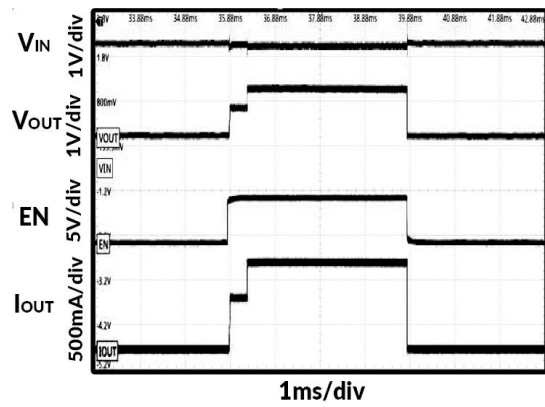

Figure 24. Overload Circuit First, Then Turn On

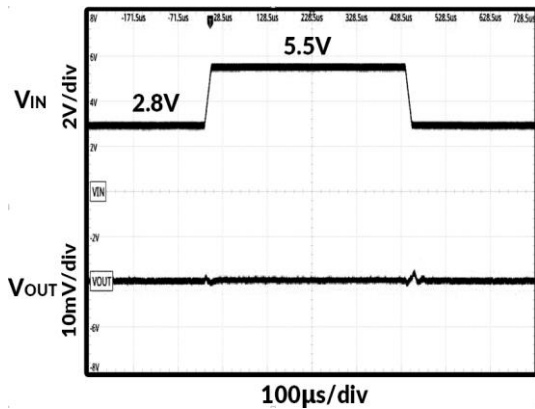

Figure 25. Line Transient Response ($I_{OUT}=1mA$)

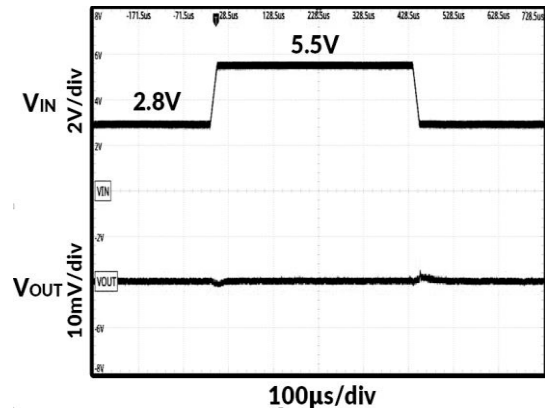

Figure 26. Line Transient Response ($I_{OUT}=30mA$)

TYPICAL PERFORMANCE CHARACTERISTICS

NOTE: The graphs and tables provided following this note are a statistical summary based on a limited number of samples and are provided for informational purposes only.

$V_{IN} = 2.8V$, $I_{OUT} = 1mA$, $C_{IN} = \text{Ceramic } 1.0\mu F$, $C_{OUT} = \text{Ceramic } 1.0\mu F$, unless otherwise noted.

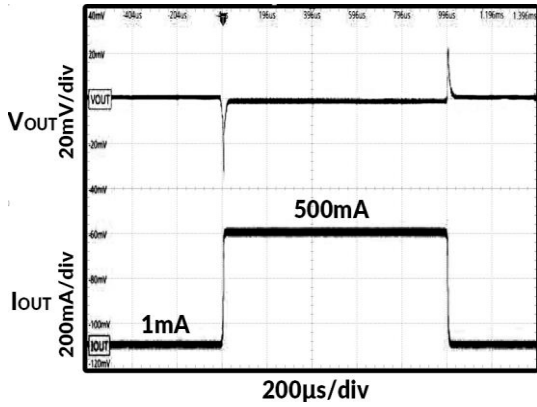

Figure 27. Load Transient Response

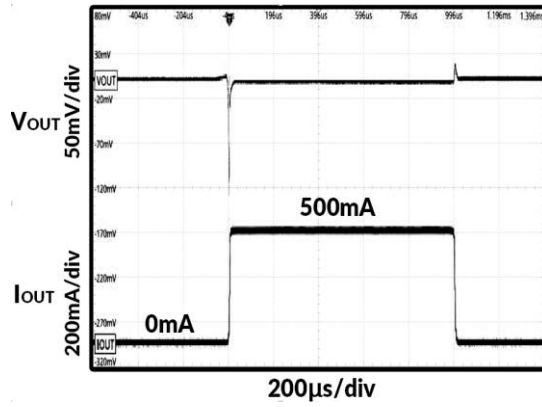

Figure 28. Load Transient Response

9 FEATURE DESCRIPTION

9.1 Overview

The RS3217 is a low-noise LDO that can supply up to 500mA output current. Designed to meet the requirements of RF and analog circuits, the RS3217 device provides low noise, high PSRR, low quiescent current, and low line or load transient response figures.

RS3217 is stable with a 1.0 μ F ceramic input and output capacitor, Using the new innovative design techniques, the RS3217 offers class-leading noise performance without a noise bypass capacitor.

RS3217 is available with fixed output voltages from 1.2V to 4.5V.

9.2 Shutdown

Enable input. A low voltage ($< V_{IL}$) on this pin turns the regulator off and discharges the output pin to GND through an internal pulldown resistor. A high voltage ($> V_{IH}$) on this pin enables the regulator output. The EN pin can be connected to the IN pin if not used. Do not leave floating.

9.3 Output Automatic Discharge

The RS3217 output employs an internal 70 Ω (typical) pulldown resistance to discharge the output when the EN pin is low, and the device is disabled.

9.4 Thermal Overload Protection (T_{SD})

Thermal shutdown disables the output when the junction temperature rises to approximately 165°C which allows the device to cool. When the junction temperature cools to approximately 150°C, the output circuitry enables.

Based on power dissipation, thermal resistance, and ambient temperature, the thermal protection circuit may cycle on and off. This thermal cycling limits the dissipation of the regulator and protects it from damage as a result of overheating.

The thermal shutdown circuitry of the RS3217 has been designed to protect against temporary thermal overload conditions. The T_{SD} circuitry was not intended to replace proper heat-sinking. Continuously running the RS3217 device into thermal shutdown may degrade device reliability.

9.5 Current-Limit Protection

The RS3217 monitors the current flowing through the output PMOS and limits the maximum current to prevent load and RS3217 from damages during current overload conditions.

9.6 Short Current-Limit Protection

The short current-limit function reduces the current-limit level down to 55mA(typical) during short circuit conditions.

10 TYPICAL APPLICATION

10.1 Input and Output Capacitor Requirements

Although an input capacitor is not required for stability, connecting a 1 μ F low-equivalent series resistance (ESR) capacitor across the input supply near the regulator is good analog design practice. This capacitor counteracts reactive input sources and improves transient response and ripple rejection. A higher value capacitor can be necessary if large, fast, rise-time load transients are anticipated or if the device is located several inches from the power source.

The RS3217 family of devices is designed to be stable with standard ceramic output capacitors of values 1 μ F or larger. X5R- and X7R-type capacitors are best because they have minimal variation in value and ESR over temperature.

11 POWER SUPPLY RECOMMENDATIONS

The device is designed to operate from an input voltage supply range between 1.9V and 5.5V. The input voltage range must provide adequate headroom in order for the device to have a regulated output. This input supply must be well regulated. If the input supply is noisy, additional input capacitors with low ESR can help improve output noise.

12 LAYOUT

For best overall performance, place all circuit components on the same side of the circuit board and as near as practical to the respective LDO pin connections. Place ground return connections to the input and output capacitor, and to the LDO ground pin as close to each other as possible, connected by a wide, component-side, copper surface. The use of vias and long traces to create LDO component connections is strongly discouraged and negatively affects system performance. This grounding and layout scheme minimizes inductive parasitics, and thereby reduces load-current transients, minimizes noise, and increases circuit stability. A ground reference plane is also recommended and is either embedded in the printed circuit board (PCB) itself or located on the bottom side of the PCB opposite the components. This reference plane serves to assure accuracy of the output voltage, shields the LDO from noise, and behaves similar to a thermal plane to spread (or sink) heat from the LDO device when connected to the exposed thermal pad. In most applications, this ground plane is necessary to meet thermal requirements.

To improve ac performance (such as PSRR, output noise, and transient response), designing the board with separate ground planes for V_{IN} and V_{OUT} is recommended, with each ground plane connected only at the GND pin of the device. In addition, the ground connection for the bypass capacitor must connect directly to the GND pin of the device.

13 PACKAGE OUTLINE DIMENSIONS SOT23-5 ⁽³⁾

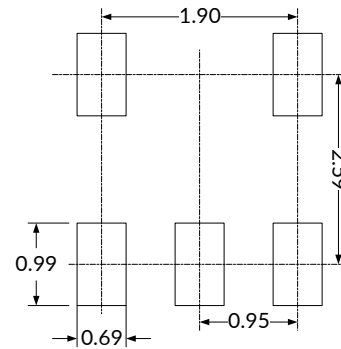
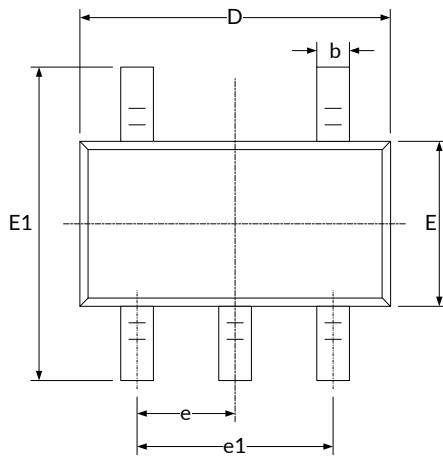
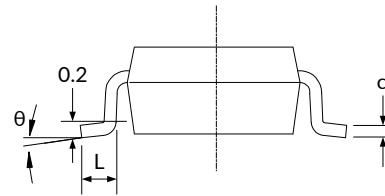
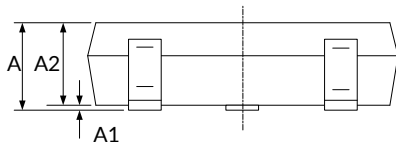
RECOMMENDED LAND PATTERN (Unit: mm)

Symbol	Dimensions In Millimeters		Dimensions In Inches	
	Min	Max	Min	Max
A ⁽¹⁾	1.050	1.250	0.041	0.049
A1	0.000	0.100	0.000	0.004
A2	1.050	1.150	0.041	0.045
b	0.300	0.500	0.012	0.020
c	0.100	0.200	0.004	0.008
D ⁽¹⁾	2.820	3.020	0.111	0.119
E ⁽¹⁾	1.500	1.700	0.059	0.067
E1	2.650	2.950	0.104	0.116
e	0.950(BSC) ⁽²⁾		0.037(BSC) ⁽²⁾	
e1	1.800	2.000	0.071	0.079
L	0.300	0.600	0.012	0.024
θ	0°	8°	0°	8°

NOTE:

1. Plastic or metal protrusions of 0.15mm maximum per side are not included.
2. BSC (Basic Spacing between Centers), "Basic" spacing is nominal.
3. This drawing is subject to change without notice.

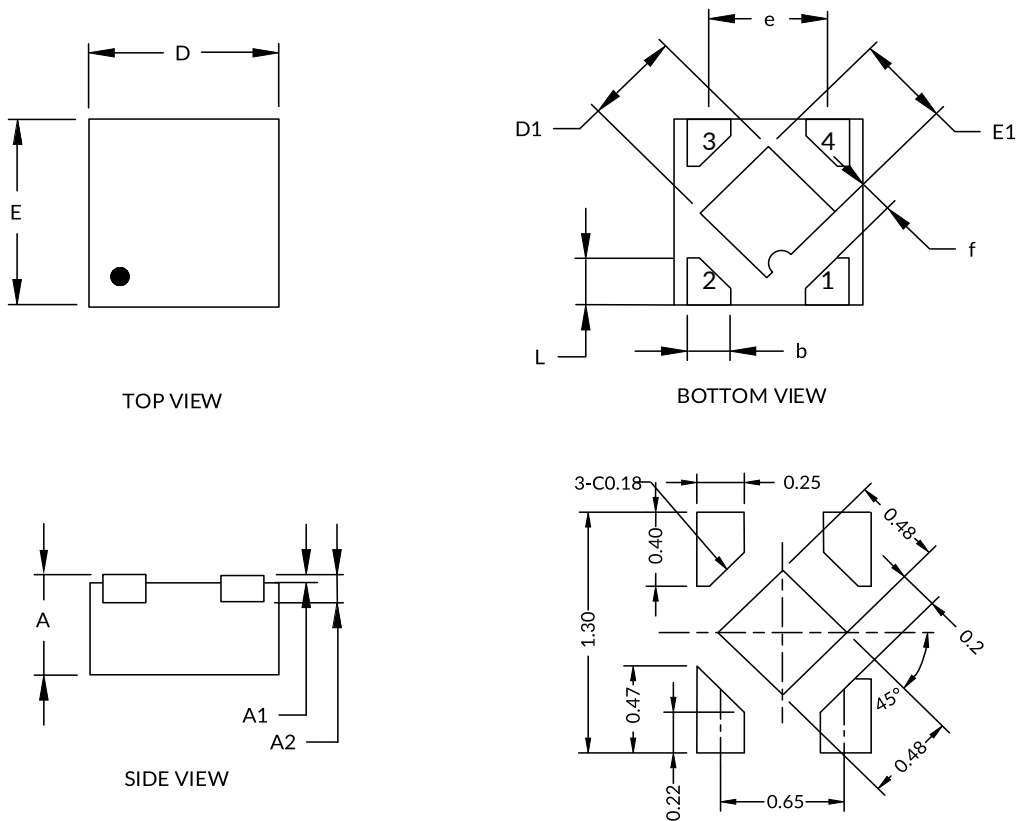
XDFN1X1-4⁽³⁾

RECOMMENDED LAND PATTERN (Unit: mm)

Symbol	Dimensions In Millimeters			Dimensions In Inches		
	MIN	TYP	MAX	MIN	TYP	MAX
A ⁽¹⁾	0.340	0.370	0.400	0.013	0.015	0.016
A1	0.000	0.020	0.050	0.000	0.001	0.002
A2	0.100 REF ⁽²⁾			0.004 REF ⁽²⁾		
D ⁽¹⁾	0.950	1.000	1.050	0.037	0.039	0.041
D1	0.430	0.480	0.530	0.017	0.019	0.021
E ⁽¹⁾	0.950	1.000	1.050	0.037	0.039	0.041
E1	0.430	0.480	0.530	0.017	0.019	0.021
b	0.170	0.220	0.270	0.007	0.009	0.011
e	0.600	0.650	0.700	0.024	0.026	0.028
f	0.195 REF ⁽²⁾			0.008 REF ⁽²⁾		
L	0.200	0.250	0.300	0.008	0.010	0.012

NOTE:

1. Plastic or metal protrusions of 0.075mm maximum per side are not included.
2. REF is the abbreviation for Reference.
3. This drawing is subject to change without notice.

14 TAPE AND REEL INFORMATION

REEL DIMENSIONS

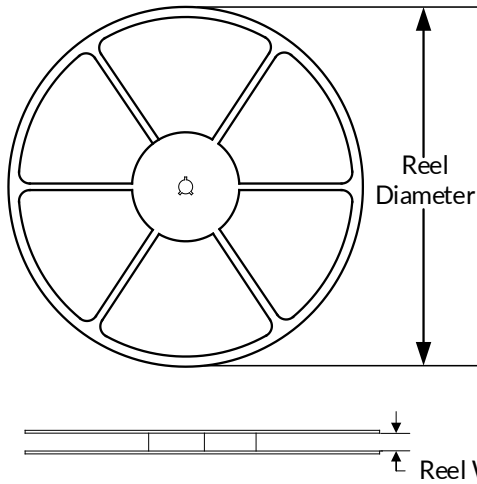

TAPE DIMENSION

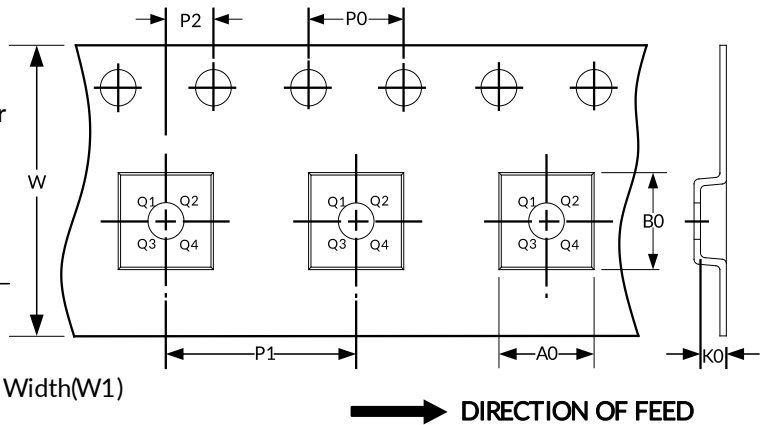

NOTE: The picture is only for reference. Please make the object as the standard.

KEY PARAMETER LIST OF TAPE AND REEL

Package Type	Reel Diameter	Reel Width(mm)	A0 (mm)	B0 (mm)	K0 (mm)	P0 (mm)	P1 (mm)	P2 (mm)	W (mm)	Pin1 Quadrant
SOT23-5	7"	9.5	3.20	3.20	1.40	4.0	4.0	2.0	8.0	Q3
XDFN1X1-4	7"	9.5	1.16	1.16	0.5	4.0	4.0	2.0	8.0	Q1

NOTE:

1. All dimensions are nominal.
2. Plastic or metal protrusions of 0.15mm maximum per side are not included.

IMPORTANT NOTICE AND DISCLAIMER

Jiangsu Runic Technology Co., Ltd. will accurately and reliably provide technical and reliability data (including data sheets), design resources (including reference designs), application or other design advice, WEB tools, safety information and other resources, without warranty of any defect, and will not make any express or implied warranty, including but not limited to the warranty of merchantability Implied warranty that it is suitable for a specific purpose or does not infringe the intellectual property rights of any third party.

These resources are intended for skilled developers designing with Runic products You will be solely responsible for: (1) Selecting the appropriate products for your application; (2) Designing, validating and testing your application; (3) Ensuring your application meets applicable standards and any other safety, security or other requirements; (4) Runic and the Runic logo are registered trademarks of Runic Incorporated. All trademarks are the property of their respective owners; (5) For change details, review the revision history included in any revised document. The resources are subject to change without notice. Our company will not be liable for the use of this product and the infringement of patents or third-party intellectual property rights due to its use.