

Zero-Drift, Rail-to-Rail I/O CMOS Operational Amplifiers

1 FEATURES

- **Low Offset Voltage: $\pm 1\mu\text{V}$ (TYP)**
- **Input Offset Drift: $\pm 0.005\mu\text{V}/^\circ\text{C}$**
- **High Gain Bandwidth Product: 350KHz**
- **Rail-to-Rail Input and Output**
- **High Gain, CMRR, PSRR: 130dB**
- **High Slew Rate: 0.17V/us**
- **Low Noise: 3.2uVp-p (0.01~10Hz)**
- **Low Power Consumption: 60uA /op amp**
- **Overload Recovery Time: 6us**
- **Low Supply Voltage: +2.3 V to +5.5 V**
- **No External Capacitors Required**
- **Extended Temperature: -40°C to +125°C**

2 APPLICATIONS

- **Temperature Sensors**
- **Medical/Industrial Instrumentation**
- **Pressure Sensors**
- **Battery-Powered Instrumentation**
- **Active Filtering**
- **Weight Scale Sensor**
- **Strain Gage Amplifiers**
- **Power Converter/Inverter**

3 DESCRIPTIONS

The RS8521, RS8522, RS8524 series of CMOS operational amplifiers use auto-zero techniques to simultaneously provide very low offset voltage (5uV max) and near-zero drift over time and temperature. This family of amplifiers has ultralow noise, offset and power.

This miniature, high-precision operational amplifiers offset high input impedance and rail-to-rail input and rail-to-rail output swing. With high gain-bandwidth product of 350KHz and slew rate of 0.17V/us.

Single or dual supplies as low as +2.3V ($\pm 1.15\text{V}$) and up to +5.5V ($\pm 2.75\text{V}$) may be used.

The RS8521/ RS8522/ RS8524 are specified for the extended industrial and automotive temperature range (-40°C to 125°C). The RS8521 single amplifier is available in 5-lead SOT23, 8-lead MSOP8 and 8-lead SOP packages, The RS8522 dual amplifier is available in 8-lead SOP and 8-lead TSSOP narrow surface mount packages. The RS8524 quad is available in 14-lead SOP and 14-lead narrow TSSOP packages.

Device Information⁽¹⁾

PART NUMBER	PACKAGE	BODY SIZE (NOM)
RS8521	SOT23-5	2.90mm×1.60mm
	SOP8	4.90mm×3.90mm
	MSOP8	3.00mm×3.00mm
RS8522	SOP8	4.90mm×3.90mm
	MSOP8	3.00mm×3.00mm
	DFN2X2-8	2.00mm×2.00mm
RS8524	SOP14	8.65mm×3.90mm
	TSSOP14	5.00mm×4.40mm

(1) For all available packages, see the orderable addendum at the end of the data sheet.

Table of Contents

1 FEATURES	1
2 APPLICATIONS	1
3 DESCRIPTIONS	1
4 Revision History	3
5 PACKAGE/ORDERING INFORMATION ⁽¹⁾	4
6 Pin Configuration and Functions (Top View)	5
7 SPECIFICATIONS	7
7.1 Absolute Maximum Ratings	7
7.2 ESD Ratings	7
7.3 Recommended Operating Conditions	7
7.4 ELECTRICAL CHARACTERISTICS	8
7.5 TYPICAL CHARACTERISTICS	10
8 Detailed Description	13
8.1 Overview	13
8.2 OPERATING VOLTAGE	13
9 Application and Implementation	14
9.1 APPLICATION NOTE	14
9.2 Bidirectional Current-Sensing	14
9.3 Design Requirements	14
9.4 Detailed Design Procedure	14
9.5 Application Curve	15
10 Layout	16
10.1 Layout Guidelines	16
10.2 Layout Example	16
11 PACKAGE OUTLINE DIMENSIONS	17
12 TAPE AND REEL INFORMATION	23

4 Revision History

Note: Page numbers for previous revisions may differ from page numbers in the current version.

Version	Change Date	Change Item
C.1	2022/06/01	1. Update Package Qty on Page 3@RevB.8 2. Added TAPE AND REEL INFORMATION 3. Added APPLICATION NOTE 4. Change Input Bias Current vs Temperature charts on Page 5@RevB.8
C.2	2023/05/29	Added NOTE
C.3	2023/09/15	Delete RS8523 related content
C.3.1	2024/03/01	Modify packaging naming

5 PACKAGE/ORDERING INFORMATION (1)

Orderable Device	Package Type	Pin	Channel	Op Temp(°C)	Device Marking (2)	Package Qty
RS8521XF	SOT23-5	5	1	-40°C ~125°C	8521	Tape and Reel,3000
RS8521XK	SOP8	8	1	-40°C ~125°C	RS8521	Tape and Reel,4000
RS8521XM	MSOP8	8	1	-40°C ~125°C	RS8521	Tape and Reel,4000
RS8522XK	SOP8	8	2	-40°C ~125°C	RS8522	Tape and Reel,4000
RS8522XM	MSOP8	8	2	-40°C ~125°C	RS8522	Tape and Reel,4000
RS8522XTDE8	DFN2X2-8	8	2	-40°C ~125°C	8522	Tape and Reel,3000
RS8524XP	SOP14	14	4	-40°C ~125°C	RS8524	Tape and Reel,4000
RS8524XQ	TSSOP14	14	4	-40°C ~125°C	RS8524	Tape and Reel,4000

NOTE:

- (1) This information is the most current data available for the designated devices. This data is subject to change without notice and revision of this document. For browser-based versions of this data sheet, refer to the right-hand navigation.
- (2) There may be additional marking, which relates to the lot trace code information (data code and vendor code), the logo or the environmental category on the device.

6 Pin Configuration and Functions (Top View)

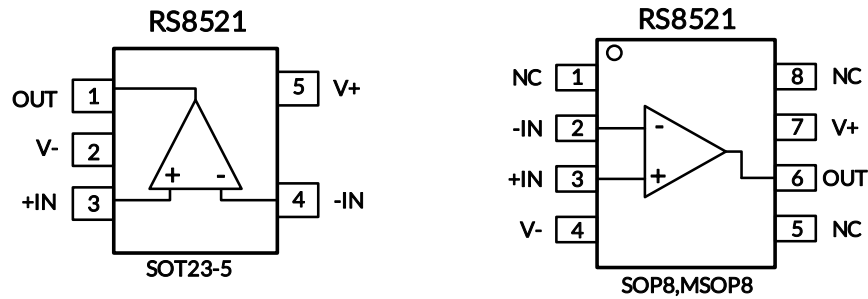

Pin Description

NAME	PIN		I/O ⁽¹⁾	DESCRIPTION
	RS8521	RS8521		
	SOT23-5	SOP8/MSOP8		
-IN	4	2	I	Negative (inverting) input
+IN	3	3	I	Positive (noninverting) input
NC ⁽²⁾	-	1,5,8	-	No internal connection (can be left floating)
OUT	1	6	O	Output
V-	2	4	-	Negative (lowest) power supply
V+	5	7	-	Positive (highest) power supply

(1) I = Input, O = Output.

(2) There is no internal connection. Typically, GND is the recommended connection to a heat spreading plane.

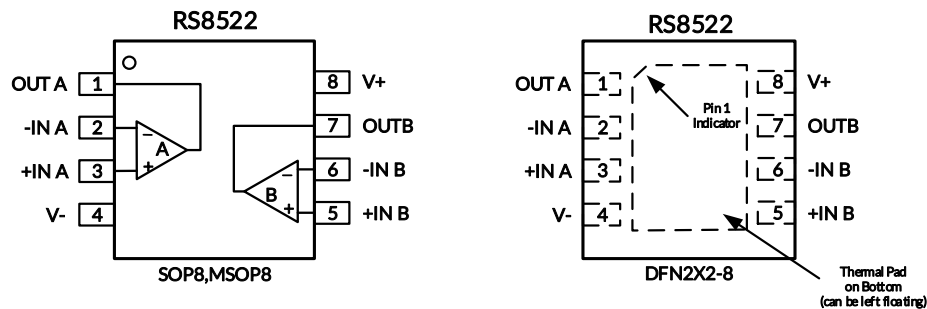

Pin Description

NAME	PIN	I/O ⁽¹⁾	DESCRIPTION
	SOP8/MSOP8/DFN2X2-8		
-INA	2	I	Inverting input, channel A
+INA	3	I	Noninverting input, channel A
-INB	6	I	Inverting input, channel B
+INB	5	I	Noninverting input, channel B
OUTA	1	O	Output, channel A
OUTB	7	O	Output, channel B
V-	4	-	Negative (lowest) power supply
V+	8	-	Positive (highest) power supply
-	Thermal Pad	-	Connect thermal pad to V-

(1) I = Input, O = Output.

Pin Configuration and Functions (Top View)

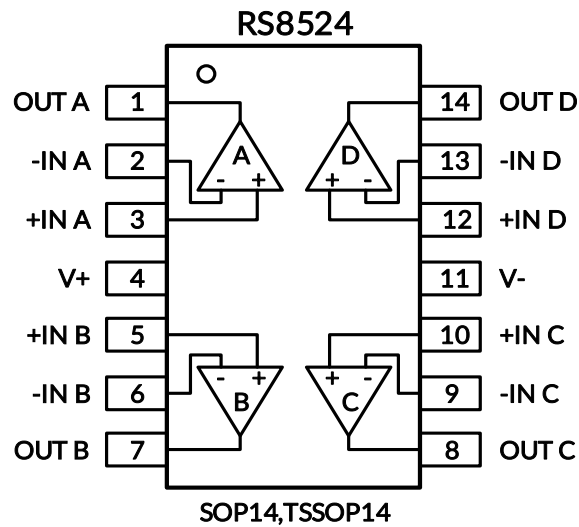

Pin Description

NAME	PIN	I/O ⁽¹⁾	DESCRIPTION
	SOP14/TSSOP14		
-INA	2	I	Inverting input, channel A
+INA	3	I	Noninverting input, channel A
-INB	6	I	Inverting input, channel B
+INB	5	I	Noninverting input, channel B
-INC	9	I	Inverting input, channel C
+INC	10	I	Noninverting input, channel C
-IND	13	I	Inverting input, channel D
+IND	12	I	Noninverting input, channel D
OUTA	1	O	Output, channel A
OUTB	7	O	Output, channel B
OUTC	8	O	Output, channel C
OUTD	14	O	Output, channel D
V-	11	-	Negative (lowest) power supply
V+	4	-	Positive (highest) power supply

(1) I = Input, O = Output.

7 SPECIFICATIONS

7.1 Absolute Maximum Ratings

Over operating free-air temperature range (unless otherwise noted) ⁽¹⁾

		MIN	MAX	UNIT
Voltage	Supply, $V_S = (V+) - (V-)$		7	V
	Signal input pin ⁽²⁾	(V-)-0.5	(V+) +0.5	
	Signal output pin ⁽³⁾	(V-)-0.5	(V+) +0.5	
Current	Signal input pin ⁽²⁾	-10	10	mA
	Signal output pin ⁽³⁾	-55	55	mA
	Output short-circuit ⁽⁴⁾	Continuous		
θ_{JA}	Package thermal impedance ⁽⁵⁾	SOT23-5	230	°C/W
		SOP8	110	
		MSOP8	170	
		SOP14	105	
		TSSOP14	90	
		DFN2X2-8	80	
Temperature	Operating range, T_A	-40	125	°C
	Junction, T_J ⁽⁶⁾	-40	150	
	Storage, T_{stg}	-65	150	

(1) Stresses above these ratings may cause permanent damage. Exposure to absolute maximum conditions for extended periods may degrade device reliability. These are stress ratings only, and functional operation of the device at these or any other conditions beyond those specified is not implied.

(2) Input terminals are diode-clamped to the power-supply rails. Input signals that can swing more than 0.5V beyond the supply rails should be current-limited to 10mA or less.

(3) Output terminals are diode-clamped to the power-supply rails. Output signals that can swing more than 0.5V beyond the supply rails should be current-limited to ± 55 mA or less.

(4) Short-circuit to ground, one amplifier per package.

(5) The package thermal impedance is calculated in accordance with JESD-51.

(6) The maximum power dissipation is a function of $T_{J(MAX)}$, $R_{\theta JA}$, and T_A . The maximum allowable power dissipation at any ambient temperature is $P_D = (T_{J(MAX)} - T_A) / R_{\theta JA}$. All numbers apply for packages soldered directly onto a PCB.

7.2 ESD Ratings

The following ESD information is provided for handling of ESD-sensitive devices in an ESD protected area only.

			VALUE	UNIT
$V_{(ESD)}$	Electrostatic discharge	Human-body model (HBM)	± 5000	V
		Machine Model (MM)	± 400	



ESD SENSITIVITY CAUTION

ESD damage can range from subtle performance degradation to complete device failure. Precision integrated circuits may be more susceptible to damage because very small parametric changes could cause the device not to meet its published specifications.

7.3 Recommended Operating Conditions

Over operating free-air temperature range (unless otherwise noted)

		MIN	NOM	MAX	UNIT
Supply voltage, $V_S = (V+) - (V-)$	Single-supply	2.3		5.5	V
	Dual-supply	± 1.15		± 2.75	

7.4 ELECTRICAL CHARACTERISTICS

Boldface limits apply over the specified temperature range, $T_A^{(9)} = -40^{\circ}\text{C}$ to $+125^{\circ}\text{C}$.

(At $T_A = +25^{\circ}\text{C}$, $V_S = 5\text{V}$, $R_L = 10\text{k}\Omega$ connected to $V_S/2$, and $V_{\text{OUT}} = V_S/2$, $V_{\text{CM}} = V_S/2$, unless otherwise noted.)⁽¹⁾

PARAMETER	SYMBOL	CONDITION	RS8521, RS8522, RS8524			
			MIN ⁽²⁾	TYP ⁽³⁾	MAX ⁽²⁾	UNIT
OFFSET VOLTAGE						
Input Offset Voltage	V_{OS}	$V_{\text{CM}} = V_S/2$	-5	± 1	5	μV
Input Offset Voltage Average Drift	$V_{\text{OS}} T_c$			± 0.005	± 0.05	$\mu\text{V}/^{\circ}\text{C}$
Power-Supply Rejection Ratio	PSRR	$V_S = +2.3\text{V}$ to $+5.5\text{V}$, $V_{\text{CM}} = 0$	110	130		dB
Channel Separation, dc				0.1		$\mu\text{V}/\text{V}$
INPUT BIAS CURRENT						
Input Bias Current ⁽⁴⁾⁽⁵⁾	I_B	$V_{\text{CM}} = V_S/2$		± 10		pA
Input Offset Current ⁽⁴⁾	I_{OS}			± 10		pA
NOISE PERFORMANCE						
Input Voltage Noise	$e_{\text{n,p-p}}$	$f = 0.01\text{Hz}$ to 10Hz		3.2		μV_{pp}
Input Voltage Noise	$e_{\text{n,p-p}}$	$f = 0.01\text{Hz}$ to 1Hz		0.97		μV_{pp}
Input Voltage Noise Density	e_n	$f = 1\text{KHz}$		140		$\text{nV}/\sqrt{\text{Hz}}$
Input Current Noise Density	i_n	$f = 10\text{Hz}$		15		$\text{fA}/\sqrt{\text{Hz}}$
INPUT VOLTAGE RANGE						
Common-Mode Voltage Range	V_{CM}		(V-) -0.1		(V+) +0.1	V
Common-Mode Rejection Ratio	CMRR	$(V-) -0.1\text{V} < V_{\text{CM}} < (V+) + 0.1\text{V}$	110	130		dB
INPUT CAPACITANCE						
Differential				1		pF
Common-Mode				5		pF
Open-Loop Gain						
Open-Loop Voltage Gain	A_{OL}	$R_L = 10\text{K}\Omega$, $V_{\text{O}} = 0.3\text{V}$ to 4.7V , $T_A = -40^{\circ}\text{C}$ to 125°C	110	130		dB
DYNAMIC PERFORMANCE						
Slew Rate ⁽⁸⁾	SR	$G = +1$		0.17		$\text{V}/\mu\text{s}$
Gain-Bandwidth Product	GBW			350		KHz
Overload Recovery Time	t_{OR}			6		μs
OUTPUT CHARACTERISTICS						
Output Voltage High	V_{OH}	$R_L = 100\text{K}\Omega$ to GND	4.99	4.998		V
		$R_L = 10\text{K}\Omega$ to GND	4.95	4.98		
Output Voltage Low	V_{OL}	$R_L = 100\text{K}\Omega$ to V+		1	10	mV
		$R_L = 10\text{K}\Omega$ to V+		10	30	
Short-Circuit Current ⁽⁶⁾⁽⁷⁾	I_{SC}			25		mA
POWER SUPPLY						
Operating Voltage Range	V_S		2.3		5.5	V
Quiescent Current/ Amplifier	I_Q			60	87	μA

NOTE:

- (1) Electrical table values apply only for factory testing conditions at the temperature indicated. Factory testing conditions result in very limited self-heating of the device.
- (2) Limits are 100% production tested at 25°C. Limits over the operating temperature range are ensured through correlations using statistical quality control (SQC) method.
- (3) Typical values represent the most likely parametric norm as determined at the time of characterization. Actual typical values may vary over time and will also depend on the application and configuration.
- (4) This parameter is ensured by design and/or characterization and is not tested in production.
- (5) Positive current corresponds to current flowing into the device.
- (6) The maximum power dissipation is a function of $T_{J(MAX)}$, $R_{\theta JA}$, and T_A . The maximum allowable power dissipation at any ambient temperature is $PD = (T_{J(MAX)} - T_A) / R_{\theta JA}$. All numbers apply for packages soldered directly onto a PCB.
- (7) Short circuit test is a momentary test.
- (8) Number specified is the slower of positive and negative slew rates.
- (9) Specified by characterization only.

7.5 TYPICAL CHARACTERISTICS

NOTE: The graphs and tables provided following this note are a statistical summary based on a limited number of samples and are provided for informational purposes only.

At $T_A = +25^{\circ}\text{C}$, $V_S=5\text{V}$, $R_L = 10\text{k}\Omega$ connected to $V_S/2$, $V_{OUT} = V_S/2$, unless otherwise noted.

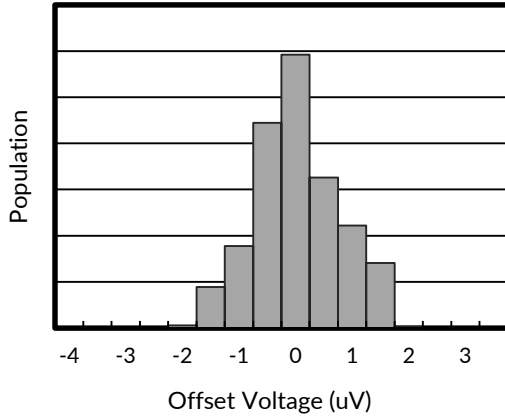

Figure 1. Offset Voltage Production Distribution

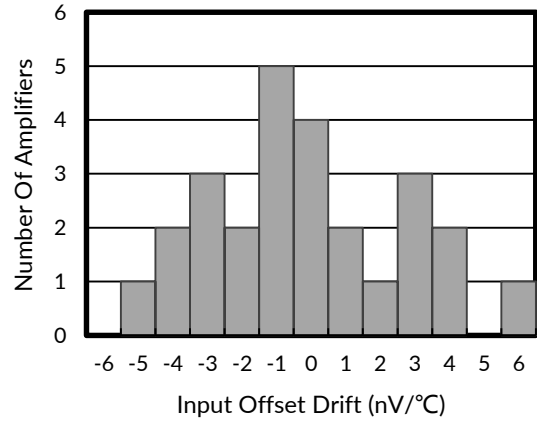

Figure 2. Offset Voltage Drift Production Distribution

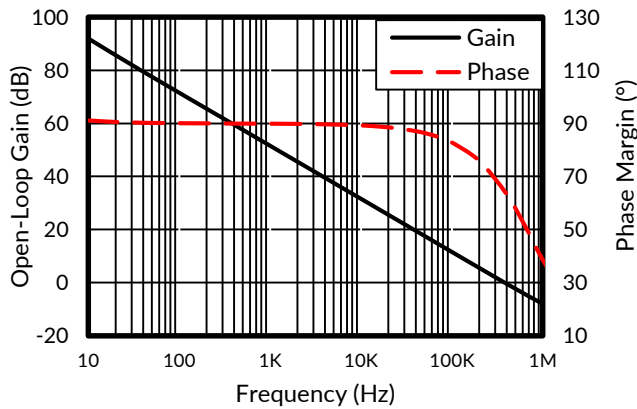

Figure 3. Open-Loop Gain and Phase vs Frequency

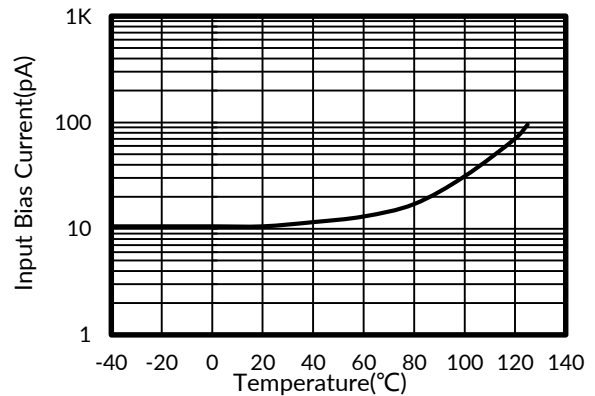

Figure 4. Input Bias Current vs Temperature

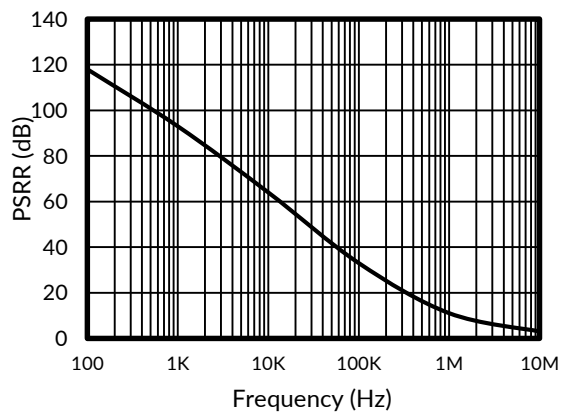

Figure 5. Power-Supply Rejection Ratio vs Frequency

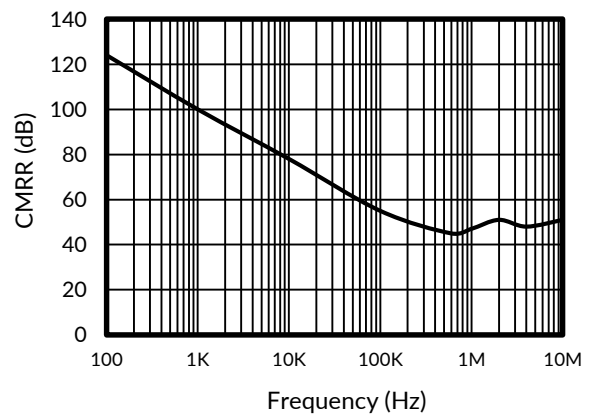

Figure 6. Common-Mode Rejection Ratio vs Frequency

TYPICAL CHARACTERISTICS

NOTE: The graphs and tables provided following this note are a statistical summary based on a limited number of samples and are provided for informational purposes only.

At $T_A = +25^\circ\text{C}$, $V_S=5\text{V}$, $R_L = 10\text{k}\Omega$ connected to $V_S/2$, $V_{OUT} = V_S/2$, unless otherwise noted.

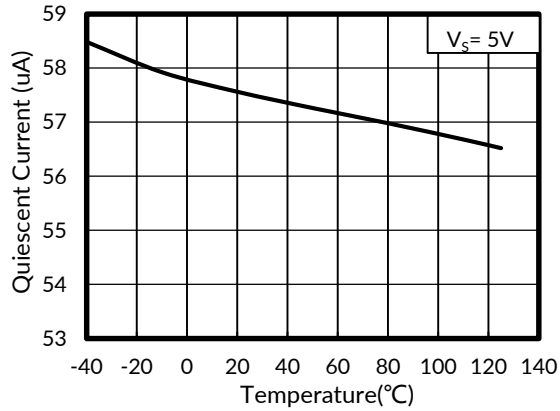

Figure 7. Quiescent Current vs Temperature

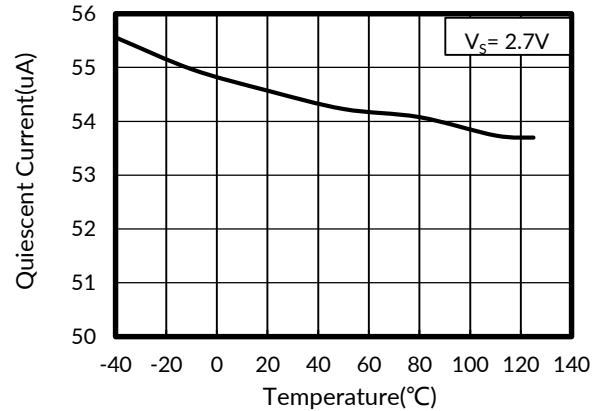

Figure 8. Quiescent Current vs Temperature

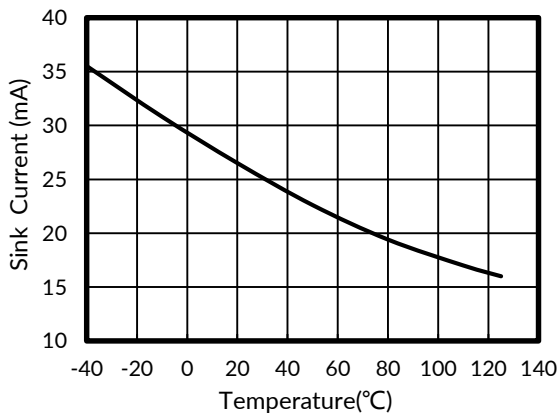

Figure 9. Sink Current vs Temperature

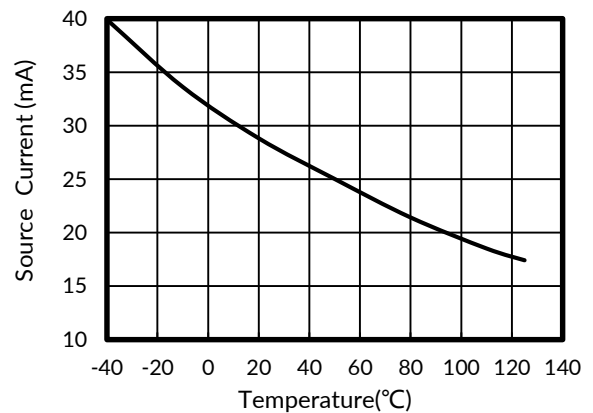

Figure 10. Source Current vs Temperature

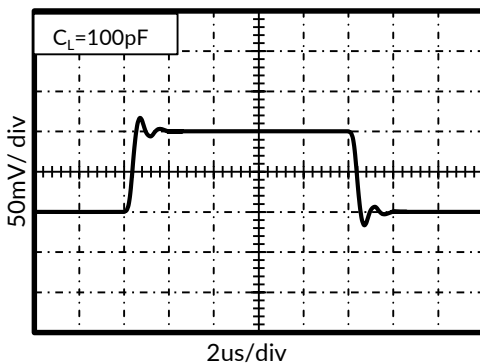

Figure 11. Small-Signal Step Response

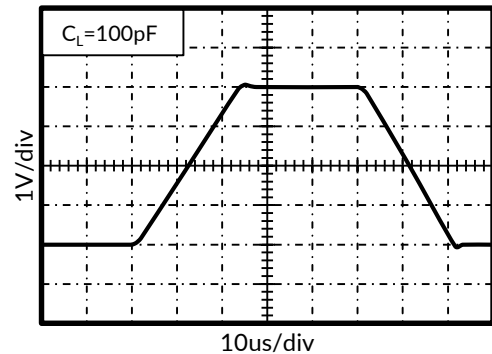

Figure 12. Large-Signal Step Response

TYPICAL CHARACTERISTICS

NOTE: The graphs and tables provided following this note are a statistical summary based on a limited number of samples and are provided for informational purposes only.

At $T_A = +25^\circ\text{C}$, $V_S = 5\text{V}$, $R_L = 10\text{k}\Omega$ connected to $V_S/2$, $V_{OUT} = V_S/2$, unless otherwise noted.

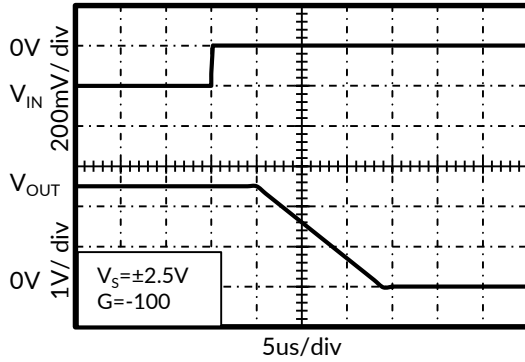

Figure 13. Positive Overtolerance Recovery

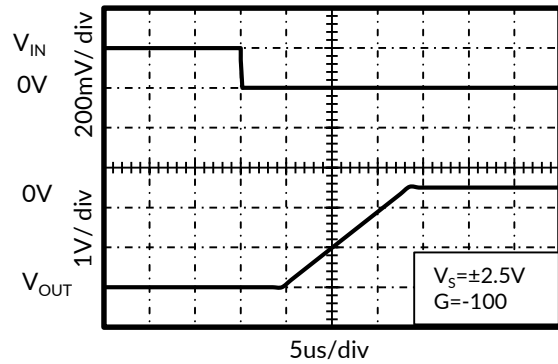

Figure 14. Negative Overtolerance Recovery

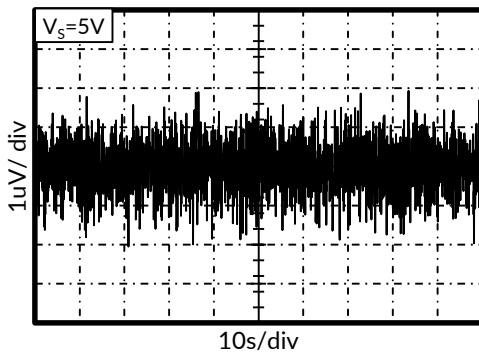

Figure 15. 0.01Hz to 10Hz Noise

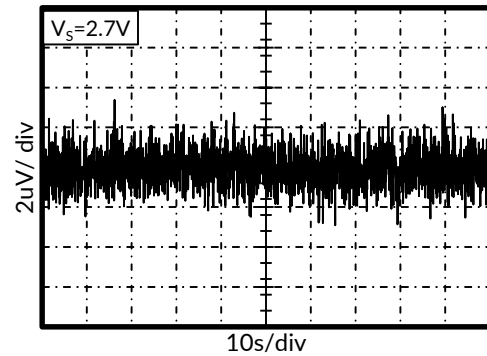

Figure 16. 0.01Hz to 10Hz Noise

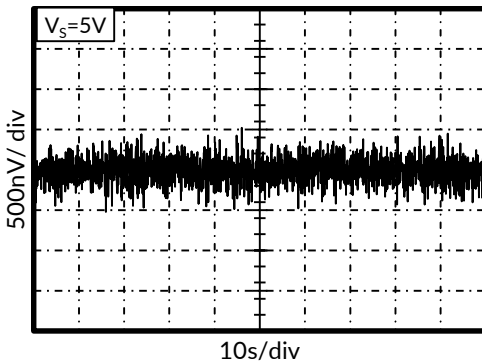

Figure 17. 0.01Hz to 1Hz Noise

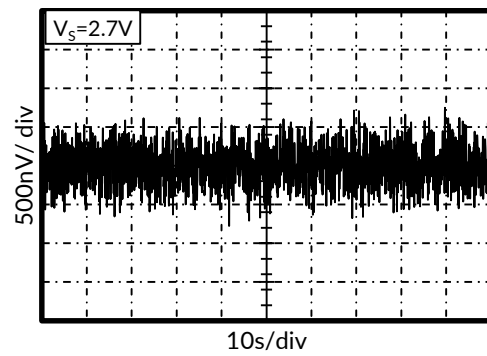

Figure 18. 0.01Hz to 1Hz Noise

8 Detailed Description

8.1 Overview

The RS8521, RS8522, RS8524 series op amps are unity-gain stable and free from unexpected output phase reversal. They use auto-zeroing techniques to provide low offset voltage and very low drift over time and temperature.

Good layout practice mandates use of a 0.1uF capacitor placed closely across the supply pins.

For lowest offset voltage and precision performance, circuit layout and mechanical conditions should be optimized. Avoid temperature gradients that create thermoelectric (Seebeck) effects in thermocouple junctions formed from connecting dissimilar conductors. These thermally-generated potentials can be made to cancel by assuring that they are equal on both input terminals.

- Use low thermoelectric-coefficient connections (avoid dissimilar metals).
- Thermally isolate components from power supplies or other heat-sources.
- Shield op amp and input circuitry from air currents, such as cooling fans.

Following these guidelines will reduce the likelihood of junctions being at different temperatures, which can cause thermoelectric voltages of 0.1uV/°C or higher, depending on materials used.

8.2 OPERATING VOLTAGE

The RS8521, RS8522, RS8524 series op amps operate over a power-supply range of +2.3V to +5.5V ($\pm 1.15V$ to $\pm 2.75V$). Supply voltages higher than 7V (absolute maximum) can permanently damage the amplifier. Parameters that vary over supply voltage or temperature are shown in the Typical Characteristics section of this data sheet.

9 Application and Implementation

Information in the following applications sections is not part of the Runic component specification, and Runic does not warrant its accuracy or completeness. Runic's customers are responsible for determining suitability of components for their purposes. Customers should validate and test their design implementation to confirm system functionality.

9.1 APPLICATION NOTE

The RS852X is a unity-gain stable, precision operational amplifier with very low offset voltage drift; these devices are also free from output phase reversal. Applications with noisy or high-impedance power supplies require decoupling capacitors close to the device power-supply pins. In most cases, 0.1uF capacitors are adequate.

Typical Applications

9.2 Bidirectional Current-Sensing

This single-supply, low-side, bidirectional current-sensing solution detects load currents from -1 A to 1 A. The single-ended output spans from 110 mV to 3.19 V. This design uses the RS852X because of its low offset voltage and rail-to-rail input and output. One of the amplifiers is configured as a difference amplifier and the other provides the reference voltage.

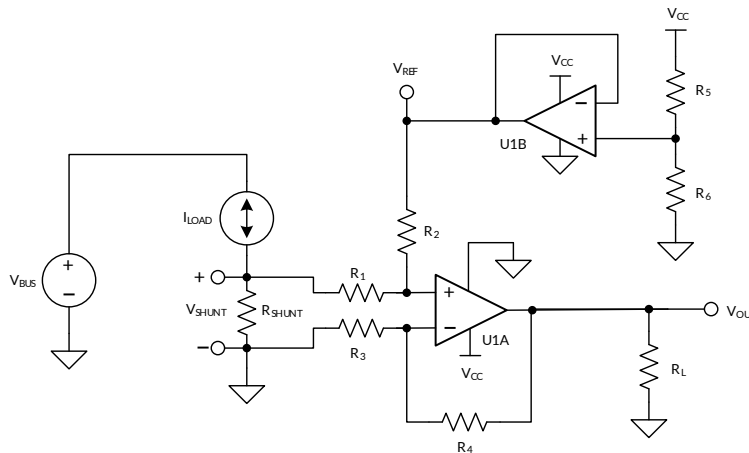

Figure 19. Bidirectional Current-Sensing Schematic

9.3 Design Requirements

This solution has the following requirements:

- Supply voltage: 3.3 V
- Input: -1 A to 1 A
- Output: 1.65 V \pm 1.54 V (110 mV to 3.19 V)

9.4 Detailed Design Procedure

The load current, I_{LOAD} , flows through the shunt resistor (R_{SHUNT}) to develop the shunt voltage, V_{SHUNT} . The shunt voltage is then amplified by the difference amplifier, which consists of U1A and R_1 through R_4 . The gain of the difference amplifier is set by the ratio of R_4 to R_3 . To minimize errors, set $R_2 = R_4$ and $R_1 = R_3$. The reference voltage, V_{REF} , is supplied by buffering a resistor divider using U1B. The transfer function is given by Equation 1.

$$V_{OUT} = V_{SHUNT} \times \text{Gain}_{\text{Diff_Amp}} + V_{REF}$$

Where

$$V_{SHUNT} = I_{LOAD} \times R_{SHUNT}$$

$$\text{Gain}_{\text{Diff_Amp}} = \frac{R_4}{R_3}$$

$$V_{REF} = V_{CC} \times \left[\frac{R_6}{R_5 + R_6} \right]$$

(1)

There are two types of errors in this design: offset and gain. Gain errors are introduced by the tolerance of the shunt resistor and the ratios of R_4 to R_3 and, similarly, R_2 to R_1 . Offset errors are introduced by the voltage divider (R_5 and R_6) and how closely the ratio of R_4/R_3 matches R_2/R_1 . The latter value impacts the CMRR of the difference amplifier, which ultimately translates to an offset error. Because this is a low-side measurement, the value of V_{SHUNT} is the ground potential for the system load. Therefore, it is important to place a maximum value on V_{SHUNT} . In this design, the maximum value for V_{SHUNT} is set to 100 mV. Equation 2 calculates the maximum value of the shunt resistor given a maximum shunt voltage of 100 mV and maximum load current of 1 A.

$$R_{SHUNT(Max)} = \frac{V_{SHUNT(Max)}}{I_{LOAD(Max)}} = \frac{100 \text{ mV}}{1 \text{ A}} = 100 \text{ m}\Omega \quad (2)$$

The tolerance of R_{SHUNT} is directly proportional to cost. For this design, a shunt resistor with a tolerance of 0.5% was selected. If greater accuracy is required, select a 0.1% resistor or better.

The load current is bidirectional; therefore, the shunt voltage range is -100 mV to 100 mV. This voltage is divided down by R_1 and R_2 before reaching the operational amplifier, U1A. Take care to ensure that the voltage present at the noninverting node of U1A is within the common-mode range of the device. Therefore, it is important to use an operational amplifier, such as the RS852X, that has a common-mode range that extends below the negative supply voltage. Finally, to minimize offset error, note that the RS852X has a typical offset voltage of $\pm 2\mu\text{V}$ ($\pm 10\mu\text{V}$ maximum). Given a symmetric load current of -1 A to 1 A, the voltage divider resistors (R_5 and R_6) must be equal. To be consistent with the shunt resistor, a tolerance of 0.5% was selected. To minimize power consumption, 10-k Ω resistors were used. To set the gain of the difference amplifier, the common-mode range and output swing of the RS852X must be considered. Equation 3 and Equation 4 depict the typical common-mode range and maximum output swing, respectively, of the RS852X given a 3.3-V supply.

$$-100\text{mV} < V_{CM} < 3.4\text{V} \quad (3)$$

$$100\text{mV} < V_{OUT} < 3.2\text{V} \quad (4)$$

The gain of the difference amplifier can now be calculated as shown in Equation 5.

$$\text{Gain}_{\text{Diff_Amp}} = \frac{V_{OUT_Max} - V_{OUT_Min}}{R_{SHUNT} \times (I_{MAX} - I_{MIN})} = \frac{3.2 \text{ V} - 100 \text{ mV}}{100 \text{ m}\Omega \times [1 \text{ A} - (-1 \text{ A})]} = 15.5 \frac{\text{V}}{\text{V}} \quad (5)$$

The resistor value selected for R_1 and R_3 was 1k Ω . 15.4k Ω was selected for R_2 and R_4 because it is the nearest standard value. Therefore, the ideal gain of the difference amplifier is 15.4 V/V.

The gain error of the circuit primarily depends on R_1 through R_4 . As a result of this dependence, 0.1% resistors were selected. This configuration reduces the likelihood that the design requires a two-point calibration. A simple one-point calibration, if desired, removes the offset errors introduced by the 0.5% resistors.

9.5 Application Curve

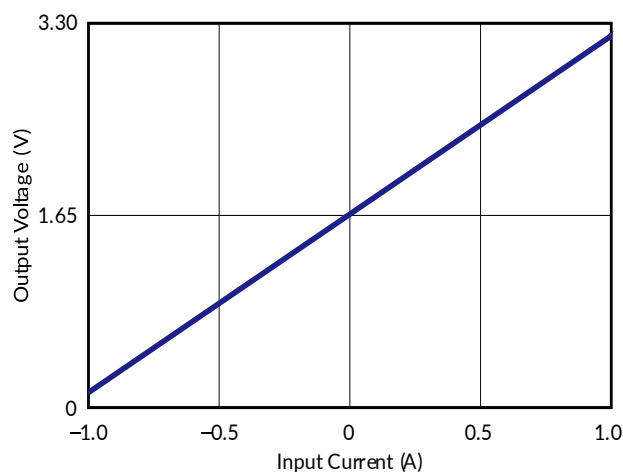

Figure 20. Bidirectional Current-Sensing Circuit Performance: Output Voltage vs Input Current

10 Layout

10.1 Layout Guidelines

Attention to good layout practices is always recommended. Keep traces short. When possible, use a PCB ground plane with surface-mount components placed as close to the device pins as possible. Place a 0.1uF capacitor closely across the supply pins.

These guidelines should be applied throughout the analog circuit to improve performance and provide benefits such as reducing the EMI susceptibility.

10.2 Layout Example

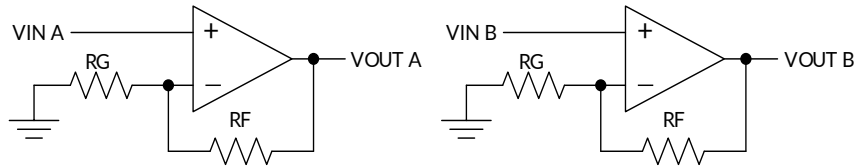

Figure 21. Schematic Representation

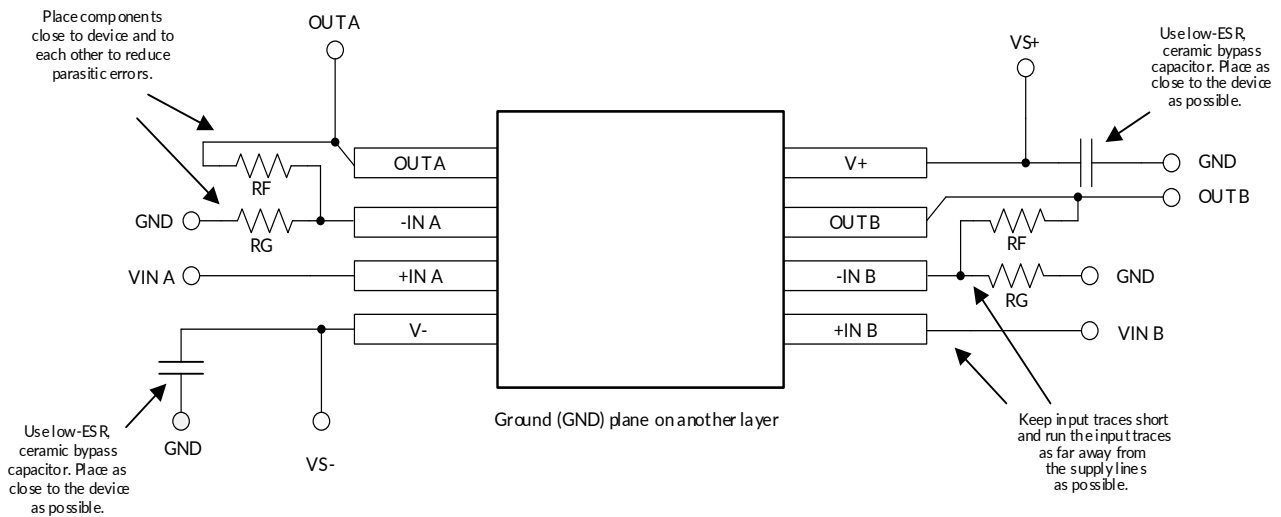
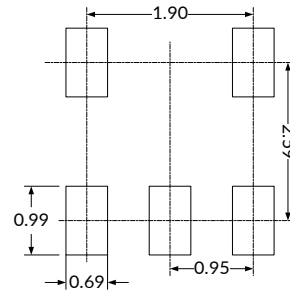
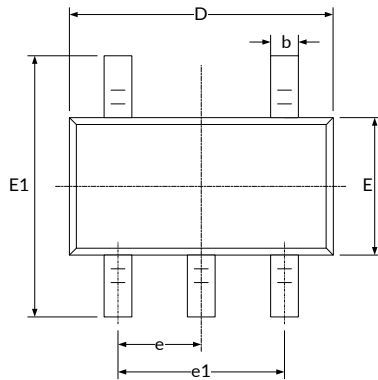
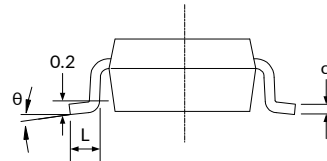
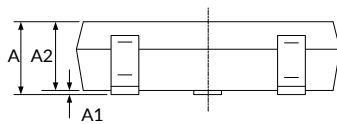

Figure 22. Layout Example

NOTE: Layout Recommendations have been shown for dual op-amp only, follow similar precautions for Single and four.

11 PACKAGE OUTLINE DIMENSIONS

SOT23-5⁽³⁾

RECOMMENDED LAND PATTERN (Unit: mm)

Symbol	Dimensions In Millimeters		Dimensions In Inches	
	Min	Max	Min	Max
A ⁽¹⁾	1.050	1.250	0.041	0.049
A1	0.000	0.100	0.000	0.004
A2	1.050	1.150	0.041	0.045
b	0.300	0.500	0.012	0.020
c	0.100	0.200	0.004	0.008
D ⁽¹⁾	2.820	3.020	0.111	0.119
E ⁽¹⁾	1.500	1.700	0.059	0.067
E1	2.650	2.950	0.104	0.116
e	0.950(BSC) ⁽²⁾		0.037(BSC) ⁽²⁾	
e1	1.800	2.000	0.071	0.079
L	0.300	0.600	0.012	0.024
θ	0°	8°	0°	8°

NOTE:

1. Plastic or metal protrusions of 0.15mm maximum per side are not included.
2. BSC (Basic Spacing between Centers), "Basic" spacing is nominal.
3. This drawing is subject to change without notice.

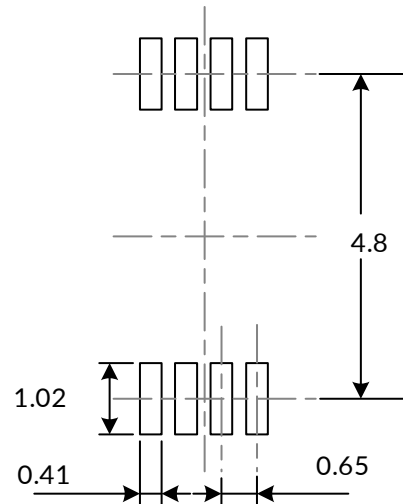
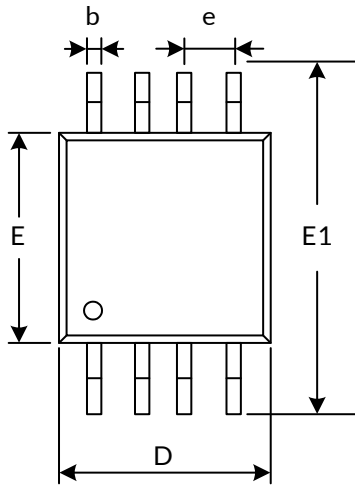
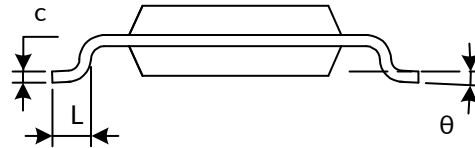
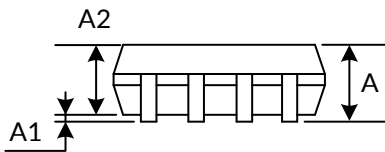
MSOP8⁽³⁾

RECOMMENDED LAND PATTERN (Unit: mm)

Symbol	Dimensions In Millimeters		Dimensions In Inches	
	Min	Max	Min	Max
A ⁽¹⁾	0.820	1.100	0.032	0.043
A1	0.020	0.150	0.001	0.006
A2	0.750	0.950	0.030	0.037
b	0.250	0.380	0.010	0.015
c	0.090	0.230	0.004	0.009
D ⁽¹⁾	2.900	3.100	0.114	0.122
e	0.650(BSC) ⁽²⁾		0.026(BSC) ⁽²⁾	
E ⁽¹⁾	2.900	3.100	0.114	0.122
E1	4.750	5.050	0.187	0.199
L	0.400	0.800	0.016	0.031
θ	0°	6°	0°	6°

NOTE:

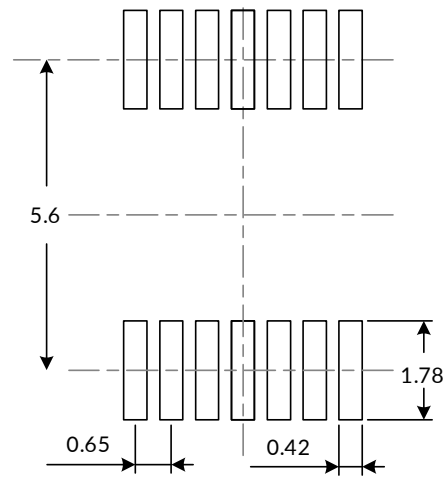
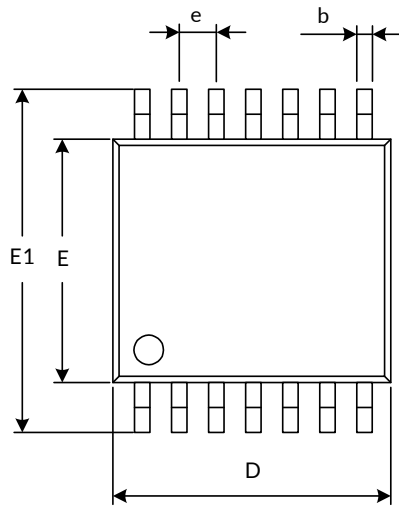
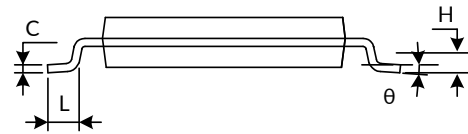
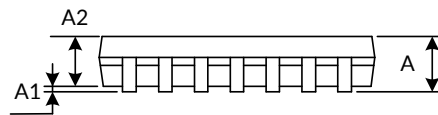
1. Plastic or metal protrusions of 0.15mm maximum per side are not included.
2. BSC (Basic Spacing between Centers), "Basic" spacing is nominal.
3. This drawing is subject to change without notice.

TSSOP14 (3)

RECOMMENDED LAND PATTERN (Unit: mm)

Symbol	Dimensions In Millimeters		Dimensions In Inches	
	Min	Max	Min	Max
A ⁽¹⁾		1.200		0.047
A1	0.050	0.150	0.002	0.006
A2	0.800	1.050	0.031	0.041
b	0.190	0.300	0.007	0.012
c	0.090	0.200	0.004	0.008
D ⁽¹⁾	4.860	5.100	0.191	0.201
E ⁽¹⁾	4.300	4.500	0.169	0.177
E1	6.250	6.550	0.246	0.258
e	0.650(BSC) ⁽²⁾		0.026(BSC) ⁽²⁾	
L	0.500	0.700	0.020	0.028
H	0.25(TYP)		0.01(TYP)	
θ	1°	7°	1°	7°

NOTE:

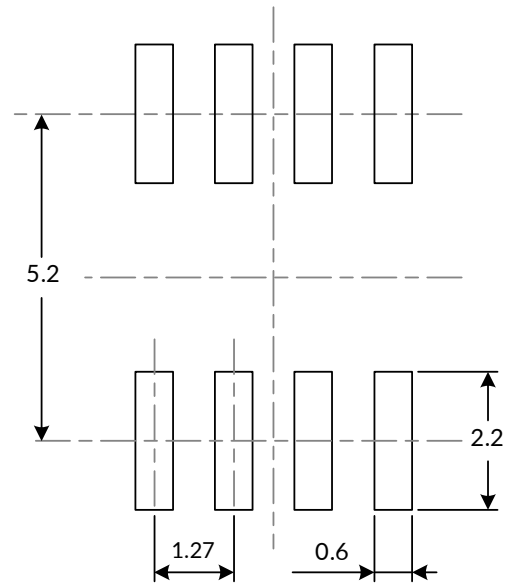
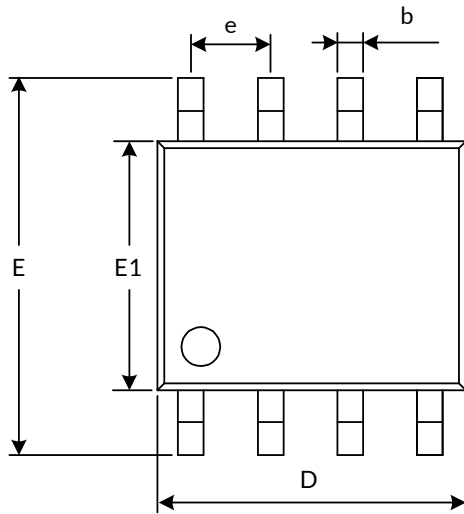
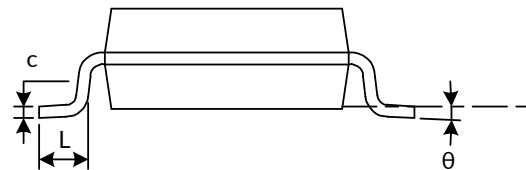
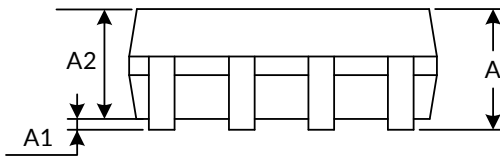
1. Plastic or metal protrusions of 0.15mm maximum per side are not included.
2. BSC (Basic Spacing between Centers), "Basic" spacing is nominal.
3. This drawing is subject to change without notice.

SOP8 (3)

RECOMMENDED LAND PATTERN (Unit: mm)

Symbol	Dimensions In Millimeters		Dimensions In Inches	
	Min	Max	Min	Max
A ⁽¹⁾	1.350	1.750	0.053	0.069
A1	0.100	0.250	0.004	0.010
A2	1.350	1.550	0.053	0.061
b	0.330	0.510	0.013	0.020
c	0.170	0.250	0.007	0.010
D ⁽¹⁾	4.800	5.000	0.189	0.197
e	1.270(BSC) ⁽²⁾		0.050(BSC) ⁽²⁾	
E	5.800	6.200	0.228	0.244
E1 ⁽¹⁾	3.800	4.000	0.150	0.157
L	0.400	1.270	0.016	0.050
θ	0°	8°	0°	8°

NOTE:

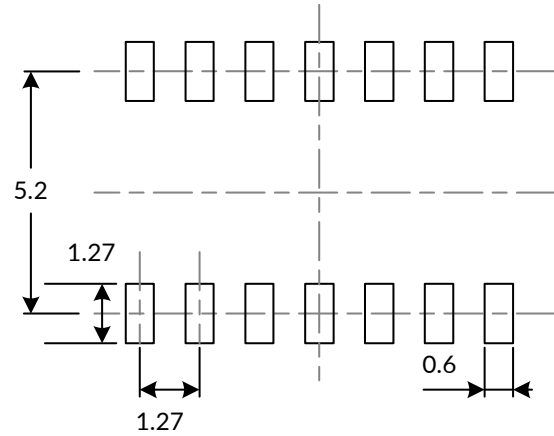
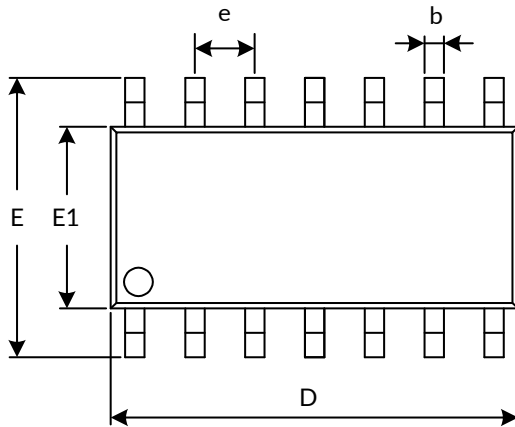
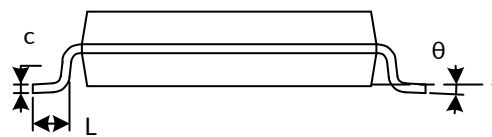
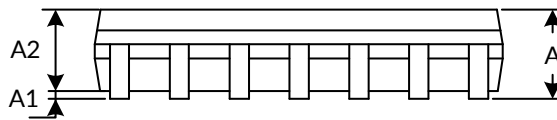
1. Plastic or metal protrusions of 0.15mm maximum per side are not included.
2. BSC (Basic Spacing between Centers), "Basic" spacing is nominal.
3. This drawing is subject to change without notice.

SOP14 (3)

RECOMMENDED LAND PATTERN (Unit: mm)

Symbol	Dimensions In Millimeters		Dimensions In Inches	
	Min	Max	Min	Max
A ⁽¹⁾	1.350	1.750	0.053	0.069
A1	0.100	0.250	0.004	0.010
A2	1.350	1.550	0.053	0.061
b	0.310	0.510	0.012	0.020
c	0.100	0.250	0.004	0.010
D ⁽¹⁾	8.450	8.850	0.333	0.348
e	1.270(BSC) ⁽²⁾		0.050(BSC) ⁽²⁾	
E	5.800	6.200	0.228	0.244
E1 ⁽¹⁾	3.800	4.000	0.150	0.157
L	0.400	1.270	0.016	0.050
θ	0°	8°	0°	8°

NOTE:

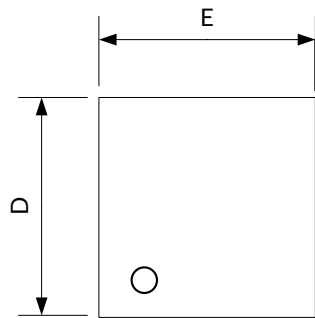
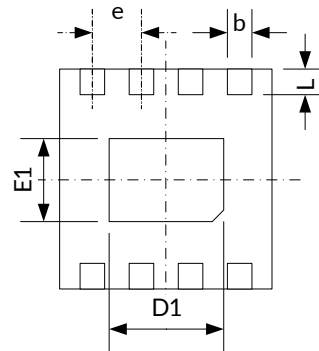
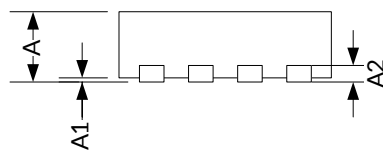
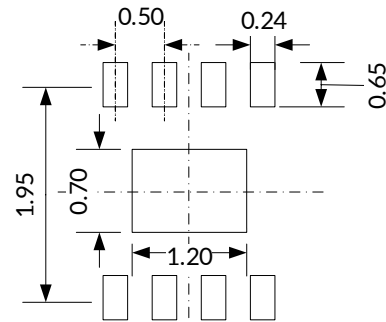
1. Plastic or metal protrusions of 0.15mm maximum per side are not included.
2. BSC (Basic Spacing between Centers), "Basic" spacing is nominal.
3. This drawing is subject to change without notice.

DFN2X2-8⁽²⁾

TOP VIEW

BOTTOM VIEW

SIDE VIEW

RECOMMENDED LAND PATTERN
(Unit: mm)

Symbol	Dimensions In Millimeters		Dimensions In Inches	
	Min	Max	Min	Max
A ⁽¹⁾	0.700	0.800	0.028	0.031
A1	0.000	0.050	0.000	0.002
A2	0.203(TYP)		0.008(TYP)	
b	0.180	0.300	0.007	0.012
D ⁽¹⁾	1.900	2.100	0.075	0.083
D1	1.100	1.300	0.043	0.051
E ⁽¹⁾	1.900	2.100	0.075	0.083
E1	0.600	0.800	0.024	0.031
e	0.500(TYP)		0.020(TYP)	
L	0.250	0.450	0.010	0.018

NOTE:

1. Plastic or metal protrusions of 0.075mm maximum per side are not included.
2. This drawing is subject to change without notice.

12 TAPE AND REEL INFORMATION

REEL DIMENSIONS

TAPE DIMENSION

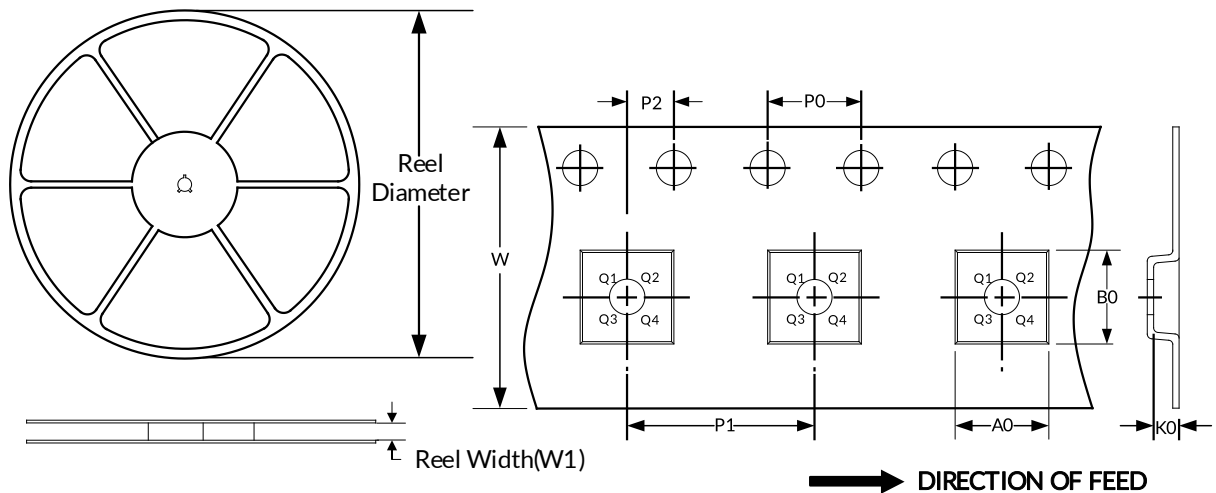

NOTE: The picture is only for reference. Please make the object as the standard.

KEY PARAMETER LIST OF TAPE AND REEL

Package Type	Reel Diameter	Reel Width (mm)	A0 (mm)	B0 (mm)	K0 (mm)	P0 (mm)	P1 (mm)	P2 (mm)	W (mm)	Pin1 Quadrant
SOT23-5	7"	9.5	3.20	3.20	1.40	4.0	4.0	2.0	8.0	Q3
MSOP8	13"	12.4	5.20	3.30	1.50	4.0	8.0	2.0	12.0	Q1
TSSOP14	13"	12.4	6.95	5.60	1.20	4.0	8.0	2.0	12.0	Q1
SOP8	13"	12.4	6.40	5.40	2.10	4.0	8.0	2.0	12.0	Q1
SOP14	13"	16.4	6.60	9.30	2.10	4.0	8.0	2.0	16.0	Q1
DFN2X2-8	7"	9.5	2.30	2.30	1.10	4.0	4.0	2.0	8.0	Q2

NOTE:

1. All dimensions are nominal.
2. Plastic or metal protrusions of 0.15mm maximum per side are not included.

IMPORTANT NOTICE AND DISCLAIMER

Jiangsu Runic Technology Co., Ltd. will accurately and reliably provide technical and reliability data (including data sheets), design resources (including reference designs), application or other design advice, WEB tools, safety information and other resources, without warranty of any defect, and will not make any express or implied warranty, including but not limited to the warranty of merchantability Implied warranty that it is suitable for a specific purpose or does not infringe the intellectual property rights of any third party.

These resources are intended for skilled developers designing with Runic products You will be solely responsible for: (1) Selecting the appropriate products for your application; (2) Designing, validating and testing your application; (3) Ensuring your application meets applicable standards and any other safety, security or other requirements; (4) Runic and the Runic logo are registered trademarks of Runic Incorporated. All trademarks are the property of their respective owners; (5) For change details, review the revision history included in any revised document. The resources are subject to change without notice. Our company will not be liable for the use of this product and the infringement of patents or third-party intellectual property rights due to its use.