Nano-Power, CMOS Input, RRIO, Push-Pull Output Comparator

1 FEATURES

- **Qualified for Automotive Applications**
- **AEC-Q100 Qualified with the Grade 1**
- **Low Supply Current**
650nA (TYP) at $V_s = 5V$
- **Low Input Offset Voltage: $V_{os(max)} = \pm 3.5mV$**
- **Rail-to-Rail Input and output**
- **Supply Range: +1.4V to +5.5V**
- **Specified Up To +125°C**
- **Micro SIZE PACKAGES: SOT23-5**

2 APPLICATIONS

- **Overvoltage and Undervoltage Detection**
- **Multivibrators**
- **Overcurrent Detection**
- **System Monitoring**
- **Battery Powered System**

3 DESCRIPTIONS

The RS8907-Q1 offers a wide supply range, low quiescent current 650nA (TYP), and rail-to-rail inputs. All of these features come in industry-standard and extremely small packages, making this device an excellent choice for low-voltage and low-power applications for portable electronics and industrial systems.

Featuring a push-pull output stage, the RS8907-Q1 allows for operation with absolute minimum power consumption when driving any capacitive or resistive load.

The devices are ideal for system monitoring, include tablets, portable medical, smart phones. The RS8907-Q1 is specified at the full temperature range of -40°C to +125°C under single power supplies of 1.4V to 5.5V.

Device Information ⁽¹⁾

PART NUMBER	PACKAGE	BODY SIZE (NOM)
RS8907-Q1	SOT23-5	1.60mm×2.92mm

(1) For all available packages, see the orderable addendum at the end of the data sheet.

Table of Contents

1 FEATURES	1
2 APPLICATIONS	1
3 DESCRIPTIONS	1
4 REVISION HISTORY	3
5 PACKAGE/ORDERING INFORMATION ⁽¹⁾	4
6 PIN CONFIGURATION AND FUNCTIONS (TOP VIEW)	5
7 SPECIFICATIONS	6
7.1 Absolute Maximum Ratings	6
7.2 ESD Ratings	6
7.3 Recommended Operating Conditions	6
7.4 ELECTRICAL CHARACTERISTICS	7
7.5 TYPICAL CHARACTERISTICS	9
8 DETAILED DESCRIPTION	15
8.1 Overview	15
8.2 Functional Block Diagram	15
8.3 Feature Description	15
8.4 Input Stage	15
8.5 Output Stage	15
8.6 Output Current	15
9 APPLICATION AND IMPLEMENTATION	16
9.1 Application Information	16
9.2 Square Wave Generator	16
9.3 Design Requirements	16
9.4 Detailed Design Procedure	16
9.5 Application Curves	17
10 PACKAGE OUTLINE DIMENSIONS	18
11 TAPE AND REEL INFORMATION	19

4 REVISION HISTORY

Note: Page numbers for previous revisions may differ from page numbers in the current version.

VERSION	Change Date	Change Item
A.0	2023/12/05	Preliminary version completed
A.0.1	2024/03/06	Modify packaging naming
A.1	2024/04/24	Initial version completed

5 PACKAGE/ORDERING INFORMATION ⁽¹⁾

Orderable Device	Package Type	Pin	Channel	Lead finish/Ball material ⁽²⁾	MSL Peak Temp ⁽³⁾	Op Temp(°C)	Device Marking ⁽⁴⁾	Package Qty
RS8907XF-Q1	SOT23-5	5	1	NIPDAUAG	MSL1-260°- Unlimited	-40°C ~125°C	8907	Tape and Reel,3000

NOTE:

- (1) This information is the most current data available for the designated devices. This data is subject to change without notice and revision of this document. For browser-based versions of this data sheet, refer to the right-hand navigation.
- (2) Lead finish/Ball material. Orderable Devices may have multiple material finish options. Finish options are separated by a vertical ruled line. Lead finish/Ball material values may wrap to two lines if the finish value exceeds the maximum column width.
- (3) MSL Peak Temp. The Moisture Sensitivity Level rating according to the JEDEC industry standard classifications, and peak solder temperature.
- (4) There may be additional marking, which relates to the lot trace code information(data code and vendor code), the logo or the environmental category on the device.

6 PIN CONFIGURATION AND FUNCTIONS (TOP VIEW)

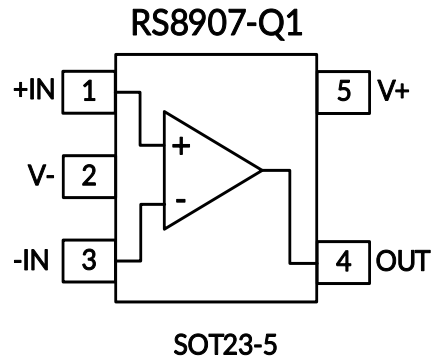

Pin Description

NAME	PIN	I/O ⁽¹⁾	DESCRIPTION
	SOT23-5		
+IN	1	I	Noninverting input
V-	2	P	Negative (lowest) power supply
-IN	3	I	Inverting input
OUT	4	O	Output
V+	5	P	Positive (highest) power supply

(1) I=Input, O=Output, P=Power.

7 SPECIFICATIONS

7.1 Absolute Maximum Ratings

Over operating free-air temperature range (unless otherwise noted) ⁽¹⁾

		MIN	MAX	UNIT
Voltage	Supply, $V_s=(V+) - (V-)$		7	V
	Input pin (IN+, IN-)	(V-)-0.5	(V+) +0.5	
	Signal output pin ⁽²⁾	(V-)-0.5	(V+) +0.5	
Current	Signal input pin (IN+, IN-)	-10	10	mA
	Signal output pin ⁽²⁾	-55	55	mA
	Output short-circuit ⁽³⁾	Continuous		
θ_{JA}	Package thermal impedance ⁽⁴⁾	SOT23-5	230	°C/W
Temperature	Operating range, T_A	-40	125	°C
	Junction, T_J ⁽⁵⁾	-40	150	
	Storage, T_{stg}	-65	150	

(1) Stresses above these ratings may cause permanent damage. Exposure to absolute maximum conditions for extended periods may degrade device reliability. These are stress ratings only, and functional operation of the device at these or any other conditions beyond those specified is not implied.

(2) Output terminals are diode-clamped to the power-supply rails. Output signals that can swing more than 0.5V beyond the supply rails should be current-limited to $\pm 55\text{mA}$ or less.

(3) Short-circuit to ground, one amplifier per package.

(4) The package thermal impedance is calculated in accordance with JESD-51.

(5) The maximum power dissipation is a function of $T_{J(MAX)}$, $R_{\theta JA}$, and T_A . The maximum allowable power dissipation at any ambient temperature is $P_D = (T_{J(MAX)} - T_A) / R_{\theta JA}$. All numbers apply for packages soldered directly onto a PCB.

7.2 ESD Ratings

The following ESD information is provided for handling of ESD-sensitive devices in an ESD protected area only.

		VALUE	UNIT
$V_{(ESD)}$ Electrostatic discharge	Human-Body Model (HBM), per AEC Q100-002 ⁽¹⁾	± 2000	V
	Charged-Device Model (CDM), per AEC Q100-011	± 1500	
	Latch-Up (LU), per AEC Q100-004	± 200	mA

(1) AEC Q100-002 indicates that HBM stressing shall be in accordance with the ANSI/ESDA/JEDEC JS-001 specification.



ESD SENSITIVITY CAUTION

ESD damage can range from subtle performance degradation to complete device failure. Precision integrated circuits may be more susceptible to damage because very small parametric changes could cause the device not to meet its published specifications.

7.3 Recommended Operating Conditions

Over operating free-air temperature range (unless otherwise noted).

		MIN	NOM	MAX	UNIT
Supply voltage, $V_s=(V+) - (V-)$	Single-supply	1.4		5.5	V
	Dual-supply	± 0.7		± 2.75	

7.4 ELECTRICAL CHARACTERISTICS

(At $T_A = +25^\circ\text{C}$, $V_S = 1.4\text{V}$ to 5.5V , $V_{CM} = V_S/2$, $C_L = 15\text{pF}$, Full = $-40^\circ\text{C} \sim +125^\circ\text{C}$, unless otherwise noted.)⁽¹⁾

PARAMETER		CONDITIONS		TEMP	RS8907-Q1			
					MIN ⁽²⁾	TYP ⁽³⁾	MAX ⁽²⁾	UINTS
POWER SUPPLY								
V_S	Operating Voltage Range			25°C	1.4		5.5	V
I_Q	Quiescent Current	$V_S = 5\text{V}$		25°C		650	1700	nA
				Full			2100	
PSRR	Power-Supply Rejection Ratio	$V_S = 1.4\text{V}$ to 5.5V , $V_{CM} = (V) + 0.5\text{V}$		25°C		70		dB
INPUT								
V_{OS}	Input Offset Voltage	$V_{CM} = V_S/2$	$V_S = 1.4\text{V}$	25°C	-6.5		6.5	mV
				Full	-7.0		7.0	
			$V_S = 5.0\text{V}$	25°C	-3.5		3.5	
				Full	-4.0		4.0	
$\Delta V_{OS}/\Delta T$	Input Offset Voltage Drift	$V_{CM} = V_S/2$		Full		± 2		$\mu\text{V}/^\circ\text{C}$
IB	Input Bias Current ⁽⁴⁾⁽⁵⁾			25°C		1	10	pA
				Full			10	nA
V_{CM}	Common-Mode Voltage Range			Full	(V-)-0.1		(V+)+0.1	V
CMRR	Common-Mode Rejection Ratio	$V_S = 5.5\text{V}$, $V_{CM} = -0.1$ to 5.6V		25°C		70		dB
OUTPUT								
V_{OH}	Output Swing From Upper Rail	$V_S = 1.4\text{V}$, $I_O = 0.1\text{mA}$		25°C		25	50	mV
				Full			60	
		$V_S = 5.0\text{V}$, $I_O = 2.5\text{mA}$		25°C		150	250	mV
				Full			300	
V_{OL}	Output Swing From Lower Rail	$V_S = 1.4\text{V}$, $I_O = -0.1\text{mA}$		25°C		20	40	mV
				Full			50	
		$V_S = 5.0\text{V}$, $I_O = -2.5\text{mA}$		25°C		100	200	mV
				Full			250	
I_{SC}	Short Circuit Sink Current	$V_S = 5.0\text{V}$		25°C	30	34		mA
				Full	22			
	Short Circuit Source Current	$V_S = 5.0\text{V}$		25°C	25	28		mA
				Full	18			
SWITCHING								
T_{PHL}	Propagation Delay H To L ⁽⁶⁾	$V_S = 5.0\text{V}$, Overdrive = 10 mV		25°C		13		μs
		$V_S = 5.0\text{V}$, Overdrive = 100 mV		25°C		9		
		$V_S = 2.5\text{V}$, Overdrive = 10 mV		25°C		12		
		$V_S = 2.5\text{V}$, Overdrive = 100 mV		25°C		8		
		$V_S = 1.4\text{V}$, Overdrive = 10 mV		25°C		13		
		$V_S = 1.4\text{V}$, Overdrive = 100 mV		25°C		9		
T_{PLH}	Propagation Delay L To H ⁽⁶⁾	$V_S = 5.0\text{V}$, Overdrive = 10 mV		25°C		30		
		$V_S = 5.0\text{V}$, Overdrive = 100 mV		25°C		21		
		$V_S = 2.5\text{V}$, Overdrive = 10 mV		25°C		24		

		Vs = 2.5 V, Overdrive = 100 mV	25°C		15		
		Vs = 1.4 V, Overdrive = 10 mV	25°C		25		
		Vs = 1.4 V, Overdrive = 100 mV	25°C		15		
T _R	Rise Time	Overdrive = 100 mV	25°C		240		ns
T _F	Fall Time	Overdrive = 100 mV	25°C		260		ns

NOTE:

- (1) Electrical table values apply only for factory testing conditions at the temperature indicated. Factory testing conditions result in very limited self-heating of the device.
- (2) Limits are 100% production tested at 25°C. Limits over the operating temperature range are ensured through correlations using statistical quality control (SQC) method.
- (3) Typical values represent the most likely parametric norm as determined at the time of characterization. Actual typical values may vary over time and will also depend on the application and configuration.
- (4) This parameter is ensured by design and/or characterization and is not tested in production.
- (5) Positive current corresponds to current flowing into the device.
- (6) High-to-low and low-to-high refers to the transition at the input.

7.5 TYPICAL CHARACTERISTICS

NOTE: The graphs and tables provided following this note are a statistical summary based on a limited number of samples and are provided for informational purposes only.

At $T_A = 25^\circ\text{C}$, $V_S = 5\text{V}$, $V_{\text{CM}} = V_S/2\text{V}$, $C_L = 10\text{pF}$, $V_{\text{OVERDRIVE}} = 20\text{mV}$ unless otherwise noted. C_L includes probe capacitance.

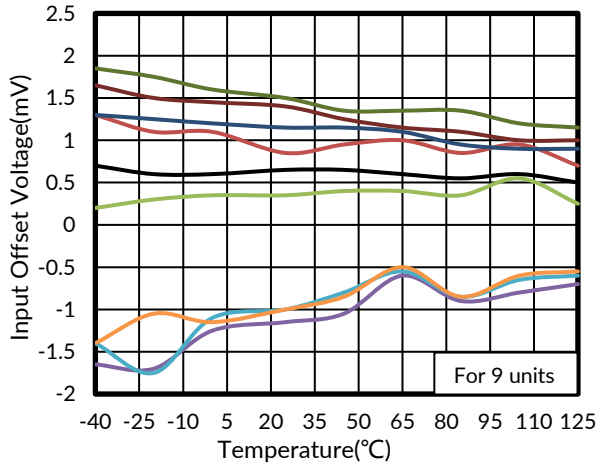

Figure 1. Input Offset Voltage vs Temperature

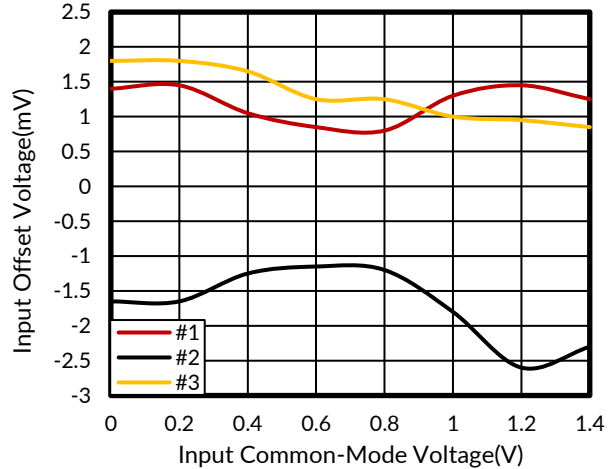

Figure 2. Offset Voltage vs Common-Mode, 1.4V

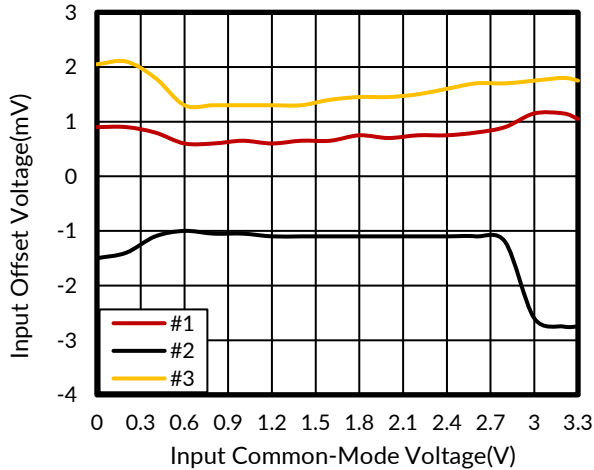

Figure 3. Offset Voltage vs Common-Mode, 3.3V

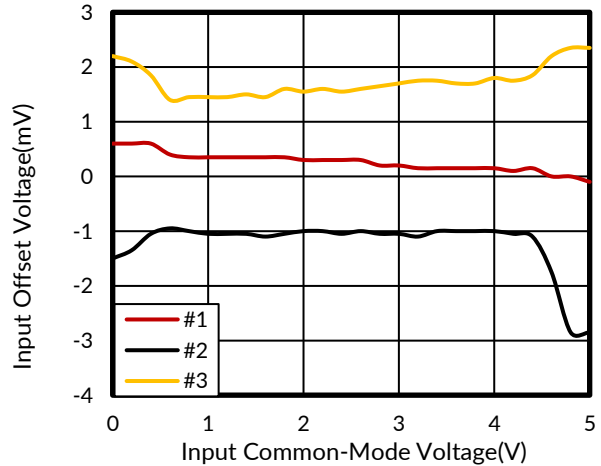

Figure 4. Offset Voltage vs Common-Mode, 5V

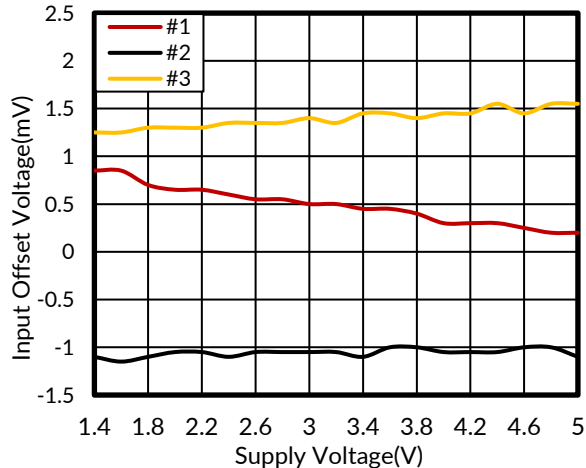

Figure 5. Offset Voltage vs Power Supply

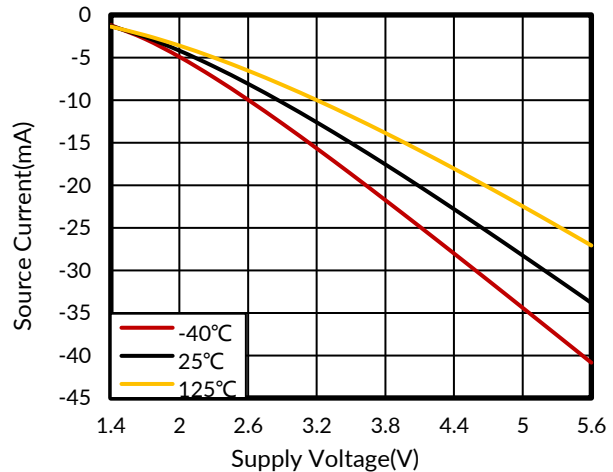

Figure 6. Source Current vs Power Supply

TYPICAL CHARACTERISTICS

NOTE: The graphs and tables provided following this note are a statistical summary based on a limited number of samples and are provided for informational purposes only.

At $T_A = 25^\circ\text{C}$, $V_S = 5\text{V}$, $V_{\text{CM}} = V_S/2\text{ V}$, $C_L = 10\text{pF}$, $V_{\text{OVERDRIVE}} = 20\text{mV}$ unless otherwise noted. C_L includes probe capacitance.

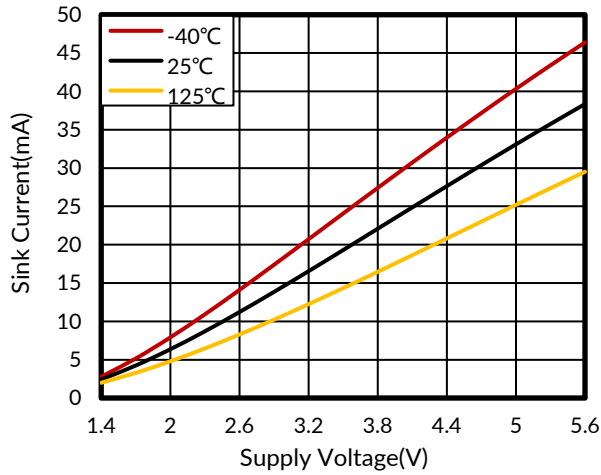

Figure 7. Sink Current vs Power Supply

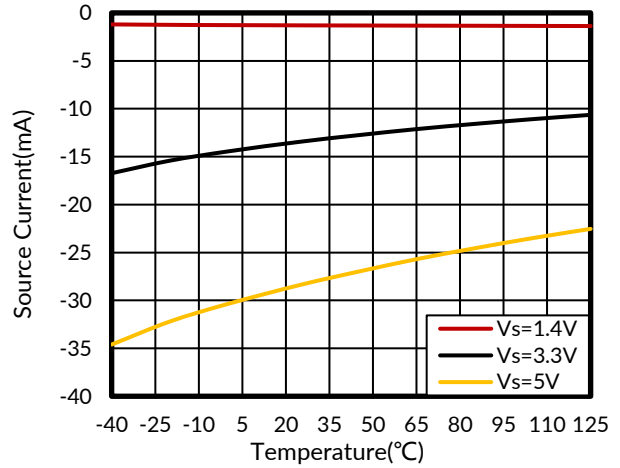

Figure 8. Source Current vs Temperature

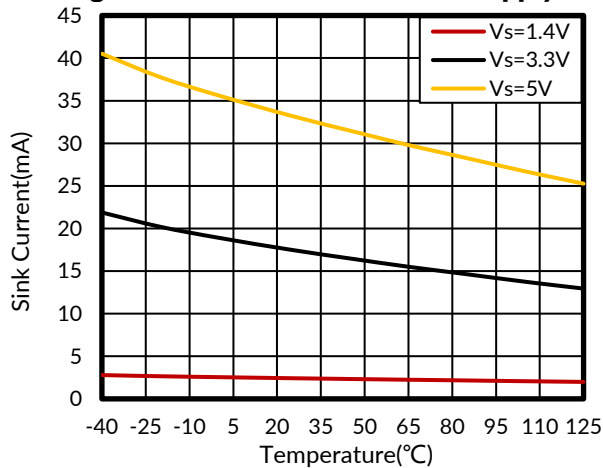

Figure 9. Sink Current vs Temperature

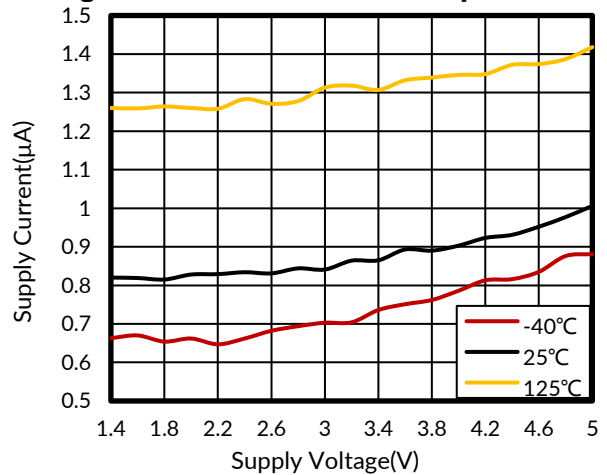

Figure 10. Supply Current vs Supply Voltage (Output High)

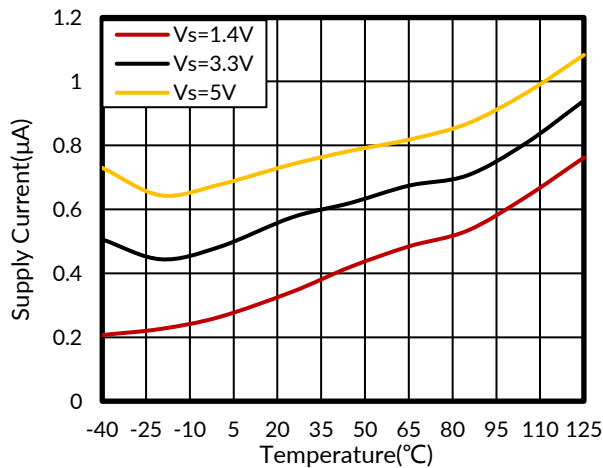

Figure 11. Supply Current vs Temperature (Output High)

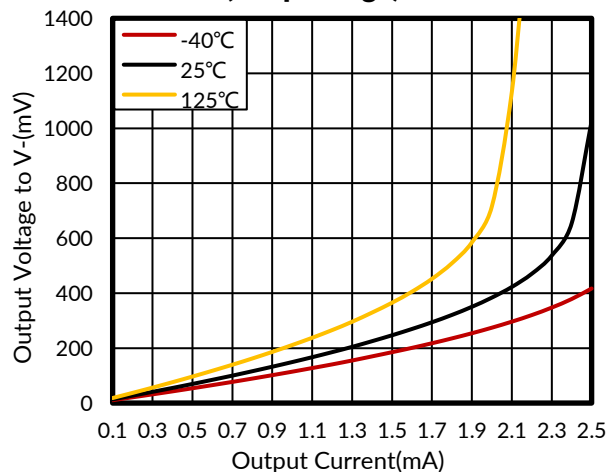

Figure 12. Output Voltage Low vs Output Current, 1.4V

TYPICAL CHARACTERISTICS

NOTE: The graphs and tables provided following this note are a statistical summary based on a limited number of samples and are provided for informational purposes only.

At $T_A = 25^\circ\text{C}$, $V_S = 5\text{V}$, $V_{CM} = V_S/2\text{V}$, $C_L = 10\text{pF}$, $V_{OVERDRIVE} = 20\text{mV}$ unless otherwise noted. C_L includes probe capacitance.

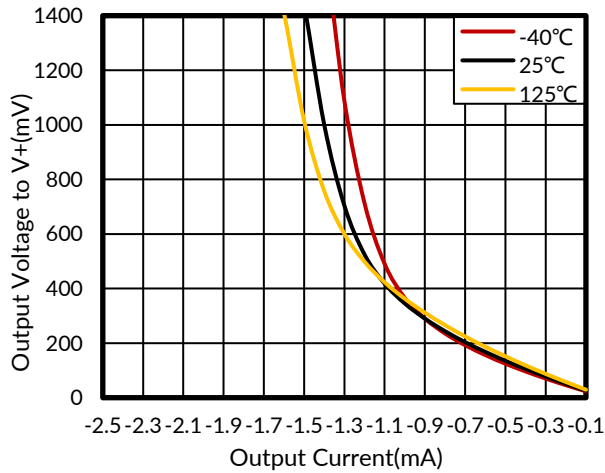

Figure 13. Output Voltage High vs Output Current, 1.4V

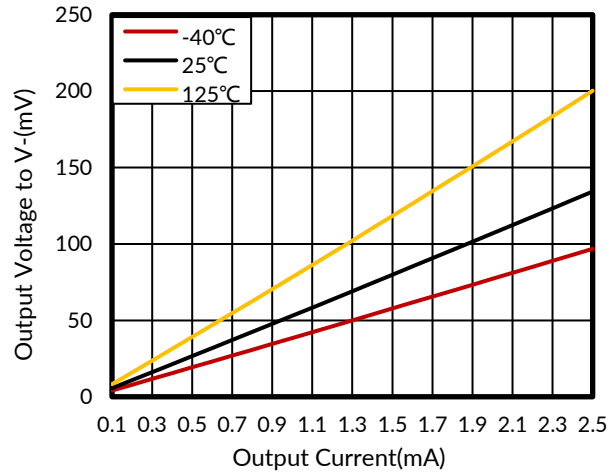

Figure 14. Output Voltage Low vs Output Current, 3.3V

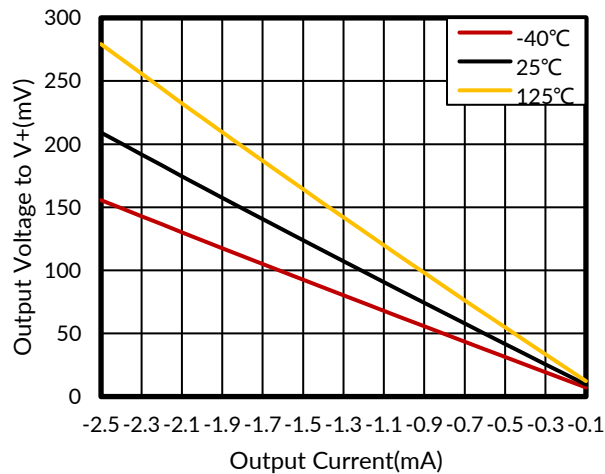

Figure 15. Output Voltage High vs Output Current, 3.3V

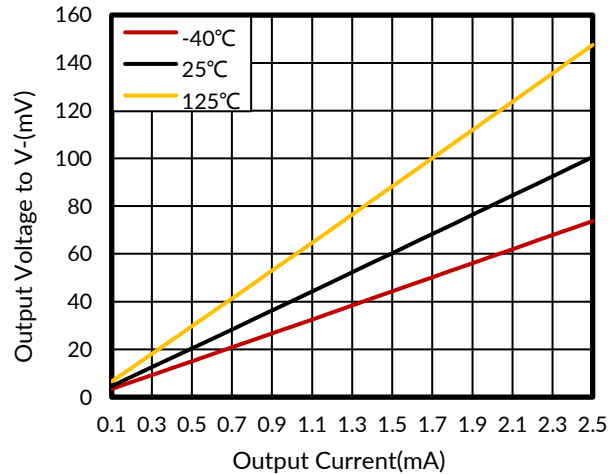

Figure 16. Output Voltage Low vs Output Current, 5V

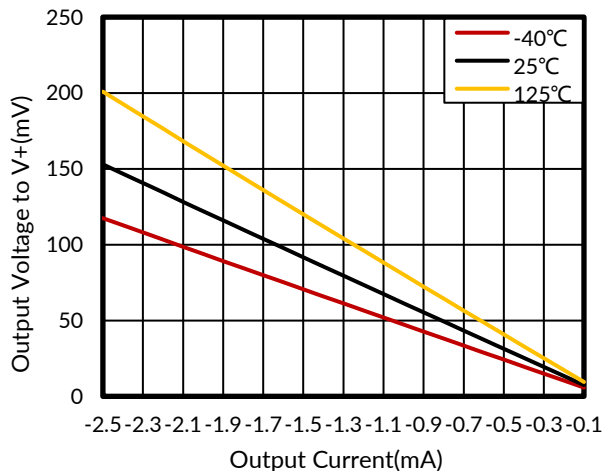

Figure 17. Output Voltage High vs Output Current, 5V

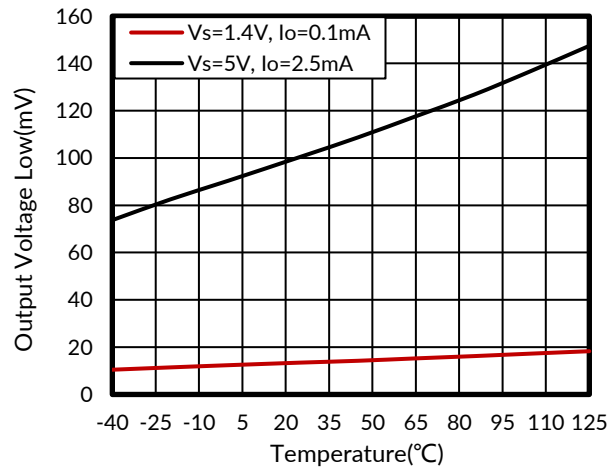

Figure 18. Output Voltage Low vs Temperature

TYPICAL CHARACTERISTICS

NOTE: The graphs and tables provided following this note are a statistical summary based on a limited number of samples and are provided for informational purposes only.

At $T_A = 25^\circ\text{C}$, $V_S = 5\text{V}$, $V_{CM} = V_S/2\text{ V}$, $C_L = 10\text{pF}$, $V_{\text{OVERDRIVE}} = 20\text{mV}$ unless otherwise noted. C_L includes probe capacitance.

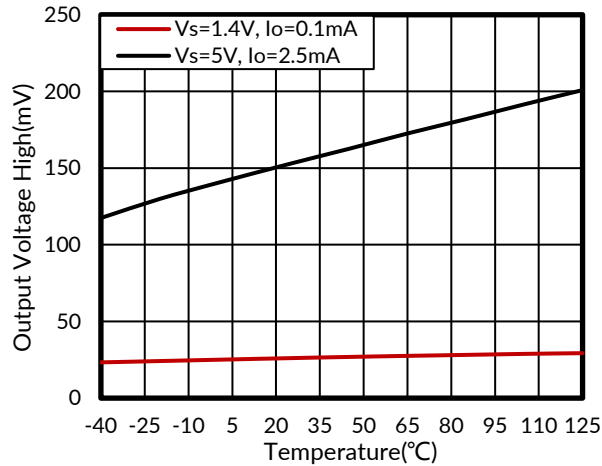

Figure 19. Output Voltage High vs Temperature

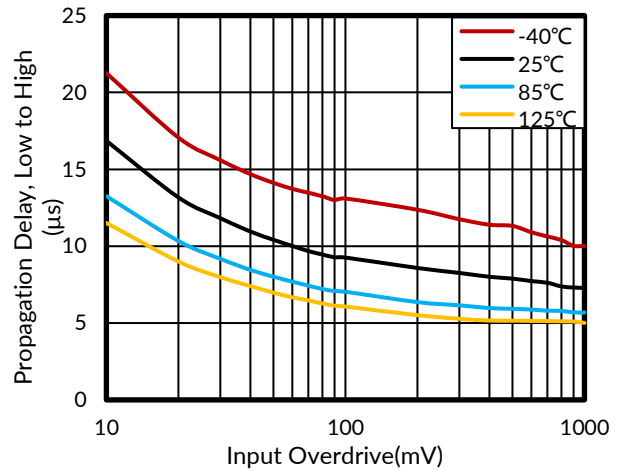

Figure 20. Propagation Delay, Low to High, 1.4V

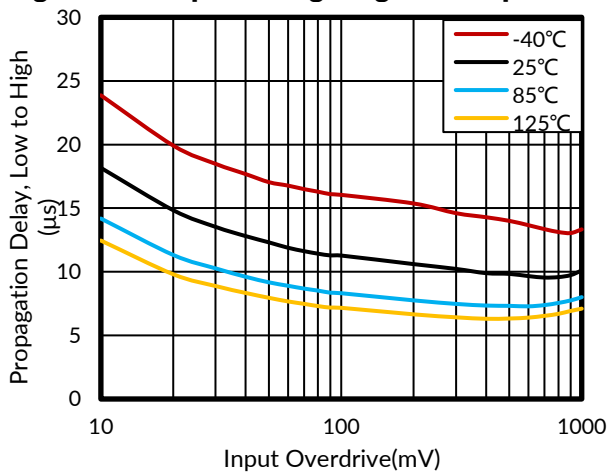

Figure 21. Propagation Delay, Low to High, 3.3V

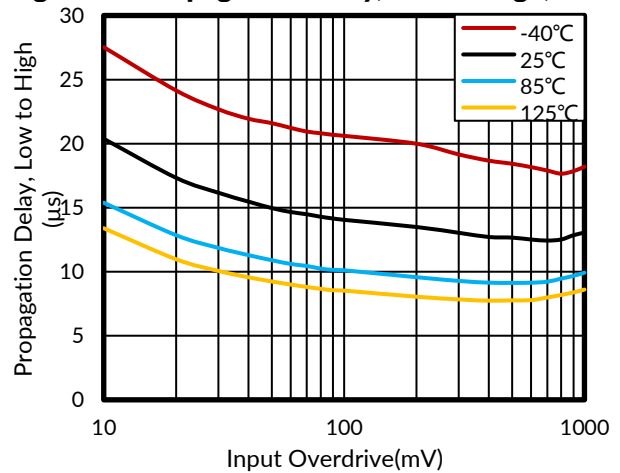

Figure 22. Propagation Delay, Low to High, 5V

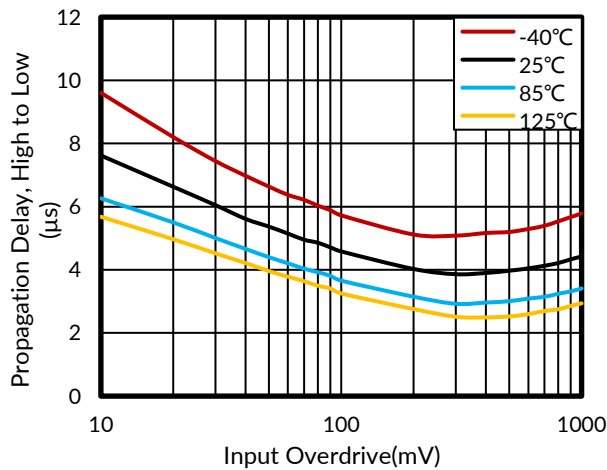

Figure 23. Propagation Delay, High to Low, 1.4V

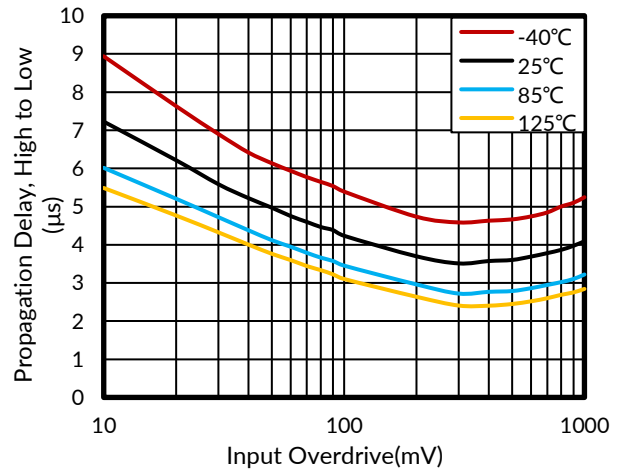

Figure 24. Propagation Delay, High to Low, 3.3V

TYPICAL CHARACTERISTICS

NOTE: The graphs and tables provided following this note are a statistical summary based on a limited number of samples and are provided for informational purposes only.

At $T_A = 25^\circ\text{C}$, $V_S = 5\text{V}$, $V_{CM} = V_S/2\text{V}$, $C_L = 10\text{pF}$, $V_{OVERDRIVE} = 20\text{mV}$ unless otherwise noted. C_L includes probe capacitance.

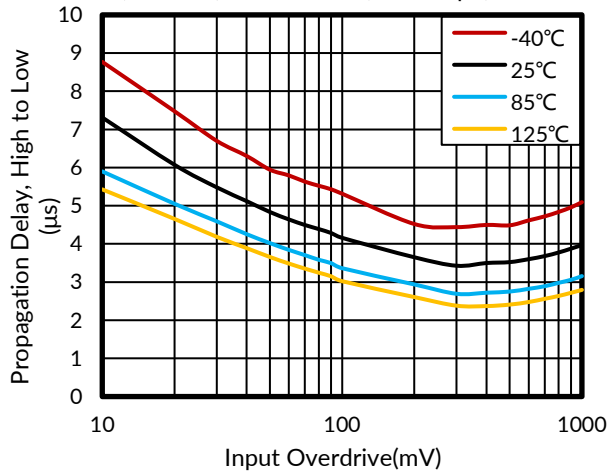

Figure 25. Propagation Delay, High to Low, 5V

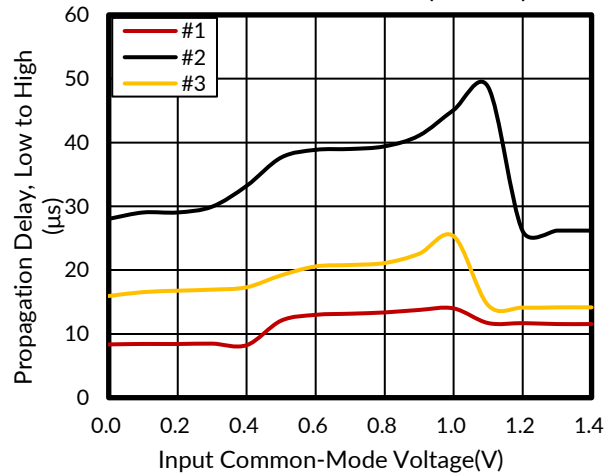

Figure 26. Propagation Delay vs Common-Mode Voltage, Low to High, 1.4V

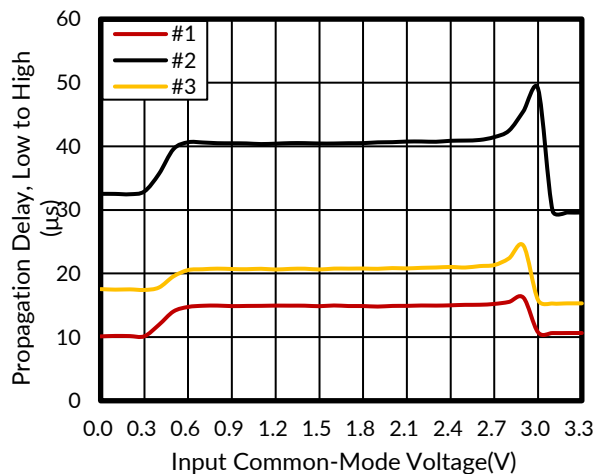

Figure 27. Propagation Delay vs Common-Mode Voltage, Low to High, 3.3V

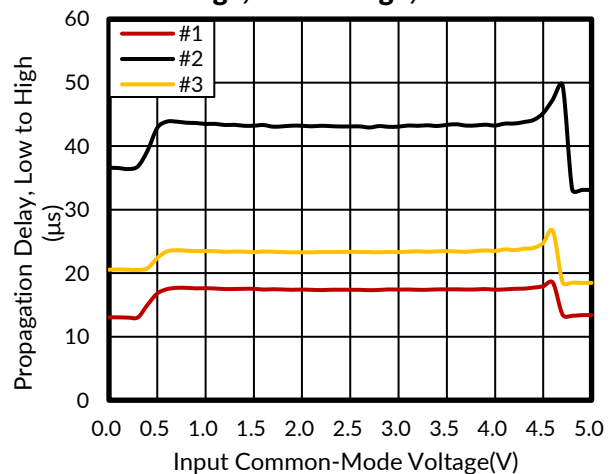

Figure 28. Propagation Delay vs Common-Mode Voltage, Low to High, 5V

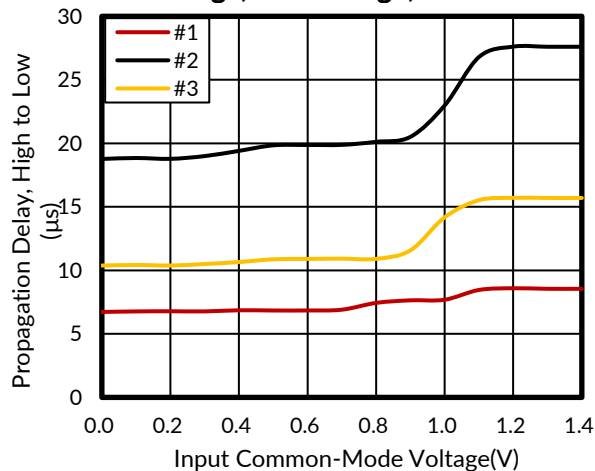

Figure 29. Propagation Delay vs Common-Mode Voltage, High to Low, 1.4V

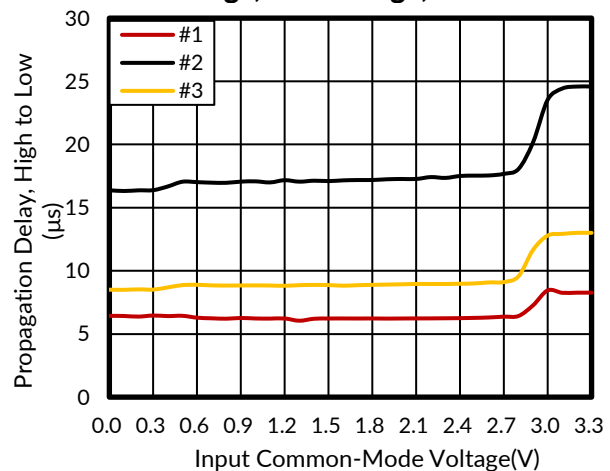

Figure 30. Propagation Delay vs Common-Mode Voltage, High to Low, 3.3V

TYPICAL CHARACTERISTICS

NOTE: The graphs and tables provided following this note are a statistical summary based on a limited number of samples and are provided for informational purposes only.

At $T_A = 25^\circ\text{C}$, $V_S = 5\text{V}$, $V_{CM} = V_S/2\text{ V}$, $C_L = 10\text{pF}$, $V_{OVERDRIVE} = 20\text{mV}$ unless otherwise noted. C_L includes probe capacitance.

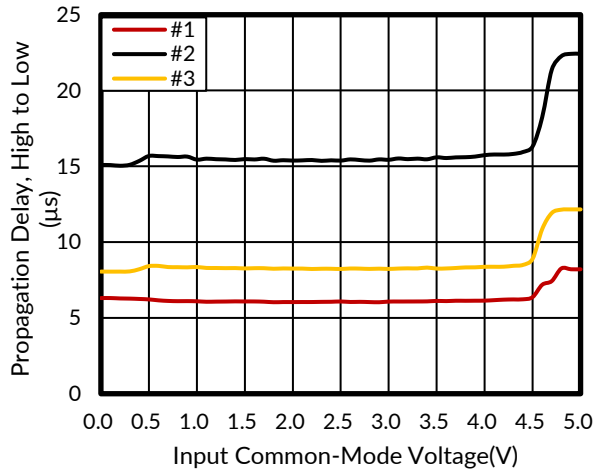

Figure 31. Propagation Delay vs Common-Mode Voltage, High to Low, 5V

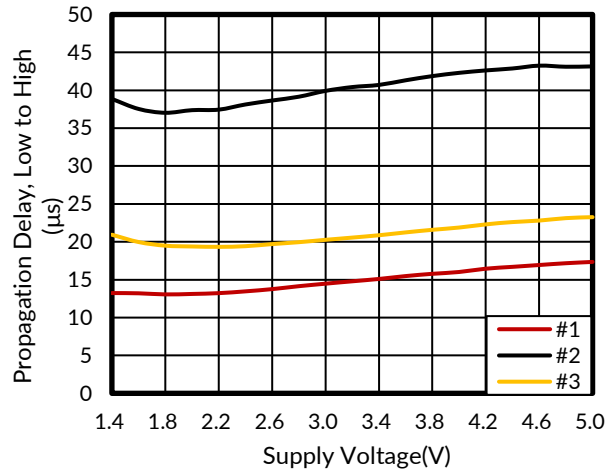

Figure 32. Propagation Delay vs Supply Voltage, Low to High

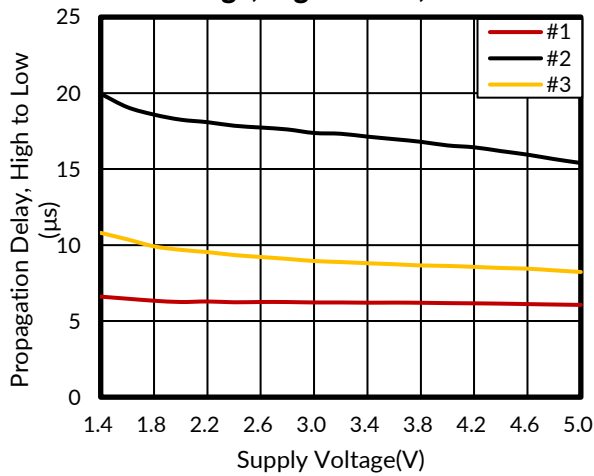

Figure 33. Propagation Delay vs Supply Voltage, High to Low

8 DETAILED DESCRIPTION

8.1 Overview

The RS8907-Q1 devices are single-channel, Nano-power comparators with a push-pull output stage. Operating from 1.4V to 5.5V and consuming only 650nA. The push-pull output of the RS8907-Q1 supports rail-to-rail output swing and interfaces with TTL/CMOS logic.

8.2 Functional Block Diagram

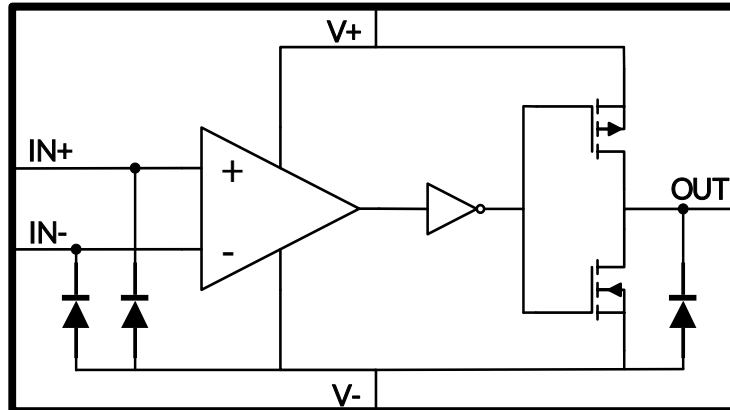

8.3 Feature Description

The RS8907-Q1 devices are Nano-Power comparators that can operate at low voltages. The RS8907-Q1 feature a rail-to-rail input stage capable of operating up to 100 mV beyond the V_{CC} power supply rail.

8.4 Input Stage

The RS8907-Q1 has rail-to-rail input common-mode voltage range. It can operate at any differential input voltage within this limit as long as the differential voltage is greater than zero. A differential input of zero volts may result in oscillation.

The differential input stage of the comparator is a pair of PMOS and NMOS transistors, therefore, no current flows into the device. The input bias current measured is the leakage current in the MOS transistors and input protection diodes. This low bias current allows the comparator to interface with a variety of circuitry and devices with minimal concern about matching the input resistances.

8.5 Output Stage

The RS8907-Q1 has a MOS push-pull rail-to-rail output stage. The push-pull transistor configuration of the output keeps the total system power consumption to a minimum. The only current consumed by the RS8907-Q1 is the less than $1\mu\text{A}$ supply current and the current going directly into the load. No power is wasted through the pullup resistor when the output is low. The output stage is specifically designed with dead time between the time when one transistor is turned off and the other is turned on (break-before-make) to minimize shoot through currents. The internal logic controls the break-before-make timing of the output transistors. The break-before-make delay varies with temperature and power condition.

8.6 Output Current

Even though the RS8907-Q1 uses less than $1\mu\text{A}$ supply current, the outputs are able to drive very large currents. The RS8907-Q1 can source up to 28mA and can sink up to 34mA, when operated at 5V supply. This large current handling capability allows driving heavy loads directly.

9 APPLICATION AND IMPLEMENTATION

Information in the following applications sections is not part of the Runic component specification, and Runic does not warrant its accuracy or completeness. Runic's customers are responsible for determining suitability of components for their purposes. Customers should validate and test their design implementation to confirm system functionality.

9.1 Application Information

The RS8907-Q1 is an ultra-low-power comparator with a typical power supply current of 650nA. It has the best-in class power supply current versus propagation delay.

Typical Applications

9.2 Square Wave Generator

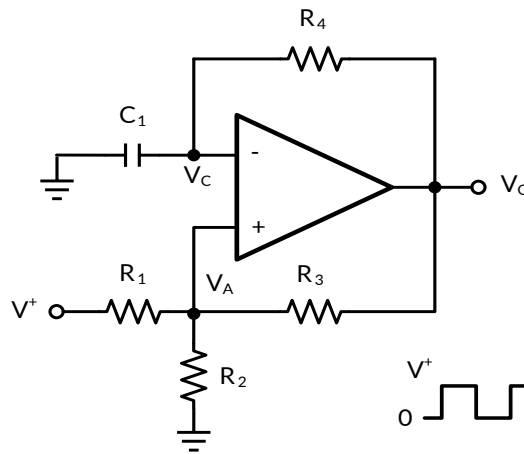

Figure 34. Square Wave Generator Schematic

9.3 Design Requirements

A typical application for a comparator is as a square wave oscillator. The circuit in Figure 34 generates a square wave whose period is set by the RC time constant of the capacitor C1 and resistor R4. The maximum frequency is limited by the large signal propagation delay of the comparator and by the capacitive loading at the output, which limits the output slew rate.

9.4 Detailed Design Procedure

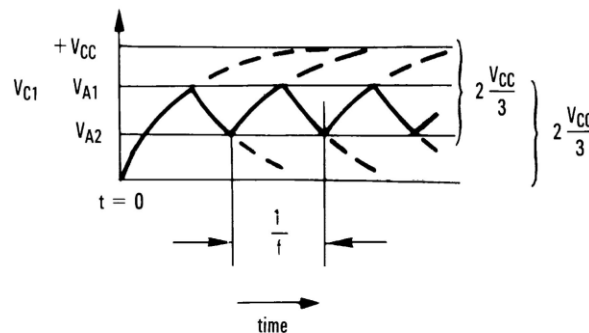

Figure 35. Square Wave Oscillator

Typical Applications(continued)

Consider the output of Figure 35 to be high to analyze the circuit. That implies that the inverted input (V_C) is lower than the noninverting input (V_A). This causes the C_1 to be charged through R_4 , and the voltage V_C increases until it is equal to the noninverting input. The value of V_A at this point is in Equation 1.

$$V_{A1} = \frac{V_{CC} \times R_2}{R_2 + R_1 \parallel R_3} \dots\dots\dots(1)$$

If $R_1 = R_2 = R_3$ then $V_{A1} = 2 V_{CC}/3$

At this point the comparator switches pulling down the output to the negative rail. The value of V_A at this point, as shown in Equation 2:

$$V_{A2} = \frac{V_{CC}(R_2 \parallel R_3)}{R_1 + (R_2 \parallel R_3)} \dots\dots\dots(2)$$

If $R_1 = R_2 = R_3$ then $V_{A2} = V_{CC}/3$ The capacitor C_1 now discharges through R_4 , and the voltage V_C decreases until it is equal to V_{A2} , at which point the comparator switches again, bringing it back to the initial stage. The time period is equal to twice the time it takes to discharge C_1 from $2 V_{CC}/3$ to $V_{CC}/3$, which is given by $R_4 C_1 \times \ln 2$. Hence the formula for the frequency is given by Equation 3:

$$F = 1 / (2 \times R_4 \times C_1 \times \ln 2) \dots\dots\dots(3)$$

9.5 Application Curves

Figure 36 shows the simulated results of an oscillator using the following values:

1. $R_1 = R_2 = R_3 = R_4 = 100k\Omega$
2. $C_1 = 100 \text{ pF}$, $C_L = 20 \text{ pF}$
3. $V_+ = 5 \text{ V}$, $V_- = \text{GND}$
4. C_{STRAY} (not shown) from V_a to $\text{GND} = 10 \text{ pF}$

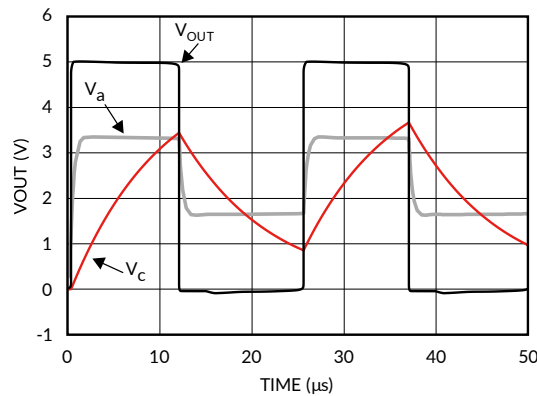
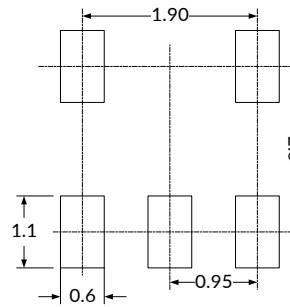
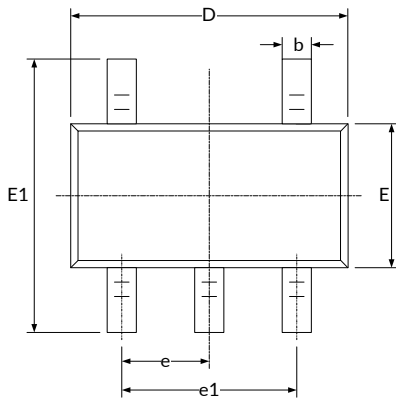
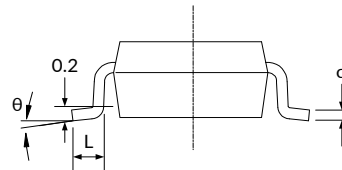
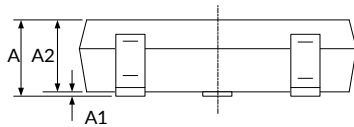

Figure 36. Square Wave Oscillator Output Waveform

10 PACKAGE OUTLINE DIMENSIONS

SOT23-5 ⁽³⁾

RECOMMENDED LAND PATTERN (Unit: mm)

Symbol	Dimensions In Millimeters		Dimensions In Inches	
	Min	Max	Min	Max
A ⁽¹⁾		1.250		0.049
A1	0.000	0.150	0.000	0.006
A2	1.000	1.200	0.039	0.047
b	0.360	0.500	0.014	0.020
c	0.100	0.200	0.004	0.008
D ⁽¹⁾	2.826	3.026	0.111	0.119
E ⁽¹⁾	1.526	1.726	0.060	0.068
E1	2.600	3.000	0.102	0.118
e	0.950(BSC) ⁽²⁾		0.037(BSC) ⁽²⁾	
e1	1.800	2.000	0.071	0.079
L	0.350	0.600	0.014	0.024
θ	0°	8°	0°	8°

NOTE:

1. Plastic or metal protrusions of 0.15mm maximum per side are not included.
2. BSC (Basic Spacing between Centers), "Basic" spacing is nominal.
3. This drawing is subject to change without notice.

11 TAPE AND REEL INFORMATION

REEL DIMENSIONS

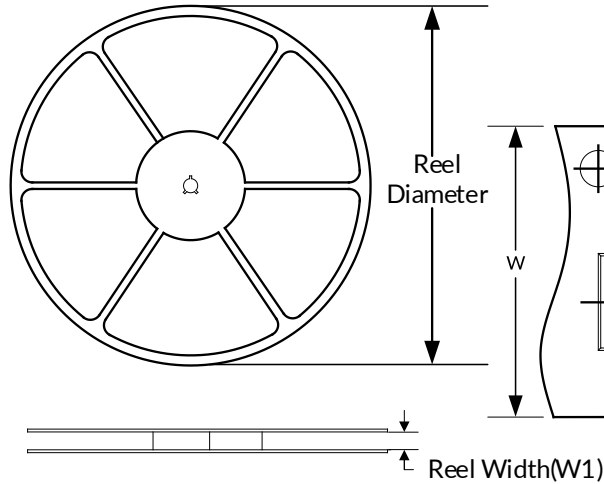

TAPE DIMENSION

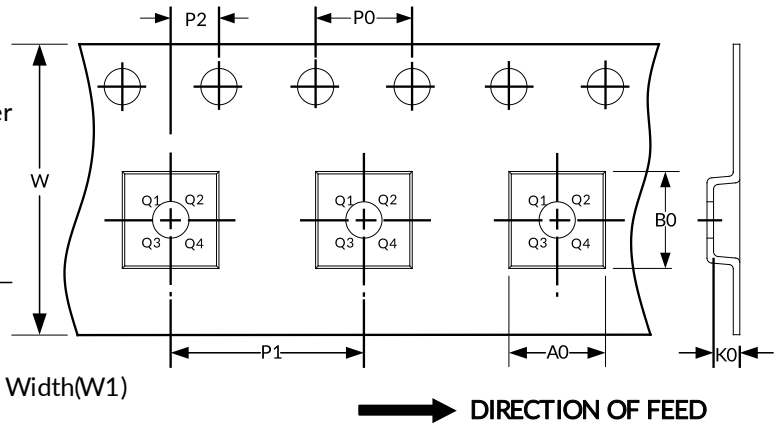

NOTE: The picture is only for reference. Please make the object as the standard.

KEY PARAMETER LIST OF TAPE AND REEL

Package Type	Reel Diameter	Reel Width(mm)	A0 (mm)	B0 (mm)	K0 (mm)	P0 (mm)	P1 (mm)	P2 (mm)	W (mm)	Pin1 Quadrant
SOT23-5	7"	9.5	3.20	3.20	1.40	4.0	4.0	2.0	8.0	Q3

NOTE:

1. All dimensions are nominal.
2. Plastic or metal protrusions of 0.15mm maximum per side are not included.

IMPORTANT NOTICE AND DISCLAIMER

Jiangsu Runic Technology Co., Ltd. will accurately and reliably provide technical and reliability data (including data sheets), design resources (including reference designs), application or other design advice, WEB tools, safety information and other resources, without warranty of any defect, and will not make any express or implied warranty, including but not limited to the warranty of merchantability Implied warranty that it is suitable for a specific purpose or does not infringe the intellectual property rights of any third party.

These resources are intended for skilled developers designing with Runic products You will be solely responsible for: (1) Selecting the appropriate products for your application; (2) Designing, validating and testing your application; (3) Ensuring your application meets applicable standards and any other safety, security or other requirements; (4) Runic and the Runic logo are registered trademarks of Runic Incorporated. All trademarks are the property of their respective owners; (5) For change details, review the revision history included in any revised document. The resources are subject to change without notice. Our company will not be liable for the use of this product and the infringement of patents or third-party intellectual property rights due to its use.